



Appendix C: IFR 3920 Test Procedures

MAINTENANCE GUIDE

Contents

Appendix C: IFR 3920 Test Procedures.....	1
MT-4E Testing with the IFR 3920 by Aeroflex	1
General Set-Up and Connections	2
Uploading Codan Configurations to the IFR 3920.....	2
Radio Service Software (RSS)	3
Control Cards	3
Adapters, Cables and Extender Cards	3
Codan MT-4E Radio System Test Sheet	3
Turning OFF the MT-4E Receiver and Transmitter Modules	4
Audio Connections	5
System Regulator Testing	6
System Voltage Testing	6
Receiver Testing.....	7
Receiver Analog Testing	7
Receiver Digital Testing	11
Receiver Bit Error Rate Testing	13
Receiver RF Preselector Alignment and Tuning.....	15
Receiver Reference Oscillator Adjustment.....	17
Transmitter Testing.....	20
Transmitter Analog Testing	20
Transmitter CTCSS Testing	26
Transmitter Digital Testing	29
System Testing.....	33
Duplex Analog Testing	33
Duplex Digital Testing	36

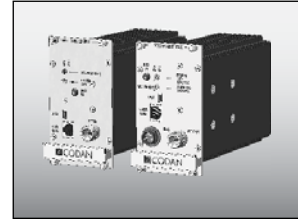

APPENDIX C: IFR 3920 TEST PROCEDURES

MT-4E TESTING WITH THE IFR 3920 BY AEROFLEX

This Chapter contains instructions for Tuning, Testing, Maintaining and Servicing MT-4E Analog and P25 Digital Radio Systems with the IFR 3920 Service Monitor by Aeroflex.

This Chapter is intended as an aid to configuring and testing Codan MT-4E radios using the IFR 3920. Neither Codan Limited or Aeroflex Inc. assume responsibility for damage caused to either unit as a result of misinterpretation or misuse of this procedure. Codan manufactured products are warranted against defective materials and workmanship. This warranty does not extend to damage due to misuse, neglect, accident, improper configuration or installation. Codan and Aeroflex shall be released from all obligations under its respective warranty in the event the Products are subject to misuse, neglect, alteration, accident, improper installation or testing, or if unauthorized repairs are performed by the customer or others.

These procedures can be modified, changed and altered at any time to better suit your specific needs and requirements. Refer to Codan Radio Communications Instruction Manuals for complete radio system specifications.



GENERAL SET-UP AND CONNECTIONS

Uploading Codan Configurations to the IFR 3920

The IFR 3920 allows for configuration files to be saved and recalled on the test set. These configuration files are uploaded to the test set from a USB flash drive and can also be uploaded from your computer if the test set is connected to your network.

The IFR 3920 configuration files are available from Codan website at www.codanradio.com. The file can be downloaded, then unzipped and copied onto a USB flash drive or transferred on the network.

To upload a file from a USB flash drive, insert the USB flash drive into the USB port and go to UTILS then File Management. The Internal directory should be selected as Stores:/ and the External directory should be selected as USB. Select the Internal Directory you would like to copy the files to (suggest Codan, then select the files on the USB and click File Copy. To select multiple files at once, hold the HOLD key.

To recall setups, double click on the UTILS button and select Store/Recall, or if you are using a mouse, right click anywhere on the screen and select Store/Recall.

Please note that some of the setups that are recalled are generic and may need to be changed for your specific receiver and transmitter settings.

The generic saved setups are as follows:

Audio = 1000 Hz @ 1.5 KHz deviation (for wideband set this to 3.0 KHz deviation)

CTCSS = 100.0 Hz @ 0.35 KHz deviation (for wideband set this to 0.5 KHz deviation)

NAC = 293

TGID = 1

Radio Service Software (RSS)

Start the RSS program on the computer and ensure you are connected to the receiver or transmitter via the type A to 5 pin mini-type B USB cable. Read the transmitter or receiver programming and familiarize yourself with the settings (RF frequency, wide / narrowband, digital / analog, CTCSS / NAC, etc.).

Control Cards

Some Codan MT-4E radio systems may have an AC-3E Audio Control Card or CI-BC-4E Base Control Card for use in the radio system. The Control Cards connect to the receiver and transmitter balanced audio lines with an unbalanced load, which could cause some measurements to be in error. If the radio system includes an AC-3E Audio Control Card or CI-BC-4E Base Control Card, remove the control card from the rack for the individual receiver and transmitter tests unless otherwise noted.

Adapters, Cables and Extender Cards

Various adapters, cables and extender cards are required for the different radio tests. Extender cards and adapters are available from Codan Radio Communications. The receiver reference oscillator and RF preselector filter tests require an SMB - BNC adapter and a small SMB - SMB cable is required for the reference oscillator test as well. The SMB adapters and cables are included in the A-TK-04 Tool Kit.

Codan MT-4E Radio System Test Sheet

A Codan MT-4E Radio System Test Sheet is included in Chapter 7 of the Maintenance Guide. It is recommended that this test sheet be filled out each time the radio system is tested. If two or more pairs of transceivers are tested, use a second test sheet to record the results. The test sheet will record settings for a single Tx and Rx frequency, however other frequencies can be tested and recorded if desired.

Turning OFF the MT-4E Receiver and Transmitter Modules

Turning the switch on the front panel of the MT-4E receiver or transmitter modules to the OFF position can cause unwanted effects on other MT-4E receiver and transmitter modules.

When the MT-4E receiver and transmitter are connected directly together with the LVDS serial data RJ45 cable, turning the MT-4E transmitter front panel switch to the OFF position will cause the MT-4E receiver module to turn off. The MT-4E receiver modules A and D LEDs on the front panel will blink on and off when this occurs. Turning the MT-4E receiver modules front panel switch to the OFF position will not cause any adverse effects on the MT-4E transmitter. When turning the MT-4E receiver modules front panel switch from the OFF to NORM position (or vice versa), it will cause the MT-4E transmitter to reboot. Remove the RJ45 cable to stop this interaction from occurring. When connecting the LVDS serial data RJ45 cables to the CI-RC-4L repeater control card or CI-RC-4M-G2 multiple link controller, the MT-4E receiver and transmitter modules are isolated from each other and the modules can be turned on or off independently of each other.

When the MT-4E receiver and transmitter channel and bank select lines are connected together in parallel, turning the MT-4E receiver or transmitter front panel switch to the OFF position will cause the channel and bank select lines to be grounded. This will cause the other MT-4E module to operate on Bank B, Channel 1 regardless of how the channel and bank select lines are set. If the bank select lines are not connected in parallel, only the channel will be affected. The channel select lines are independent of the LVDS serial data RJ45 cables (the cables will have no impact on the channel select).

When the MT-4E receiver and transmitter are connected to the antenna relay in the System Regulator module, turning the MT-4E transmitter front panel switch to the OFF position will cause the MT-4E transmitter PTT OUT line to be grounded, activating the antenna relay and causing it to be switched so that the transmitter is connected to the antenna. This makes it impossible to test the MT-4E receiver through the antenna relay when the MT-4E transmitter is turned off.

When performing maintenance on the Codan MT-4E radio system it is best to simply remove the MT-4E receiver or transmitter, that is not being tested, from the subrack and disconnect all RJ45 cables, rather than turning the front panel switch to the OFF position. All Codan modules are hot swappable. There is no need to disconnect the power supply when inserting or removing the modules from the subrack.

Audio Connections

The Receiver, Transmitter and Auxiliary Balanced audio lines are available for connection on Codan extender cards or by connecting to the optional back panel A-PNL-AUX96-3 screw-type terminal connector. The extender cards have solder points available on each signal line that can have a small test point (5059-TP110300) that is supplied with the extender card, soldered to them for easy connection with clip-on type clips. Recommended Test Points are:

Audio Control Card and Base Control Card Extender Card pins (EC-96D1 and EC-96K-1.22):

Auxiliary 1 Audio Output = B11 and A11

Auxiliary 2 Audio Output = C1 and C3 (Audio Control Card); C2 and C4 (Base Control Card)

Auxiliary 1 Audio Input = C19 and C20

Auxiliary 2 Audio Input = B14 and A14

Receiver and Transmitter Extender Card pins (EC-48RD and EC-48RK-1.22):

Rx Balanced Audio Output = B26 and Z26

Tx Balanced Audio Input = B18 and Z18

Tx Subtone Input = B22 and Ground (B32)

The test points can be soldered into the extender cards as shown in Figure C-1.

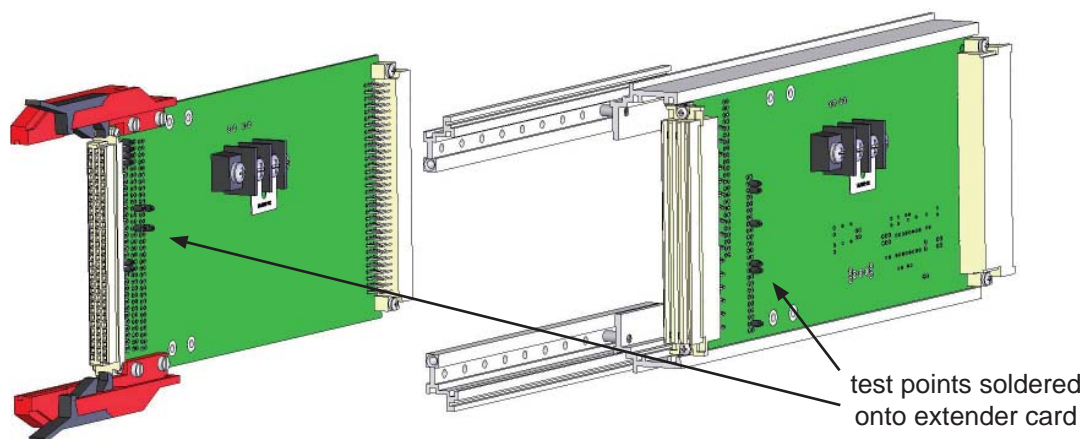

Figure C-1: EC-96D1 and EC-48RD Direct Connect Extender Cards with Test Points Added

SYSTEM REGULATOR TESTING

System Voltage Testing

The first stage of testing a Codan MT-4E radio system is to perform a basic system check on the supply and regulated voltages. The System Regulator module is designed with a convenient and easy test point built into the front panel. This test point allows a technician access to the DC supply and regulated voltages. Simply connect a standard Digital Volt Meter (DVM) to the METER jacks on the front panel of the System Regulator as shown in Figure C-2.

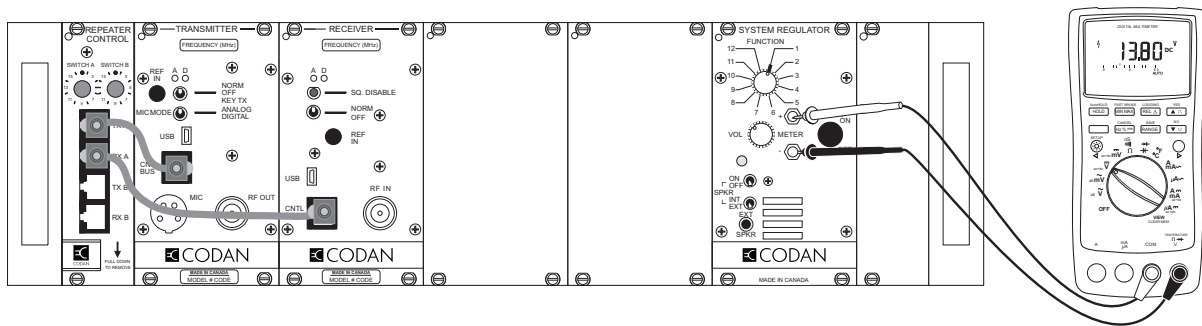

Figure C-2: System Regulator Voltage Testing

The FUNCTION rotary switch on the front panel of the System Regulator will allow you to test various points in the radio system. Following is a list of System Regulator rotary switch positions, the functions they measure and the parameters measured:

1	Supply Voltage	+10 Vdc to +17 Vdc (+13.8 Vdc nominal)
2	+9.5 Volts Regulated	+9.5 Vdc (± 0.1 Vdc)
3	Rx A Audio	Receiver A Audio (NOT Rx Balanced Output)
4	Rx A Carrier Strength	0 Vdc to +5.0 Vdc based on received signal strength (0 Vdc is a low RF signal level, +5.0 Vdc is high)
5	Rx B Audio	Receiver B Audio (NOT Rx Balanced Output)
6	Rx B Carrier Strength	0 Vdc to +5.0 Vdc based on received signal strength (0 Vdc is a low RF signal level, +5.0 Vdc is high)

Enter the Supply Voltage and +9.5 Volts Regulated values on the MT-4E Test Sheet. Inject a -100 dBm carrier signal into the Receiver and record the RSSI Voltage on the MT-4E Test Sheet. Enter the Date, Firmware Versions and Serial numbers of the Receivers and Transmitters on the MT-4E Test Sheet. The Firmware Version and Serial Number can be found by connecting the RSS and clicking on Rx ID or Tx ID. The Serial Numbers can also be found on the side of the modules.

The standby current draw of the radio system should be measured for battery / solar powered systems. Connect an ammeter to the power input line and measure the standby current draw and transmit current draw of the system. Enter the Standby Current Draw and Transmit Current Draw readings on the MT-4E Test Sheet. The maximum standby and transmit current draw is dependent on the radio system (number and class of receivers, transmitter output power, amplifiers, auxiliary equipment, etc.).

RECEIVER TESTING

Receiver Analog Testing

Connect the IFR 3920 and Codan Radio as shown in Figure C-3:

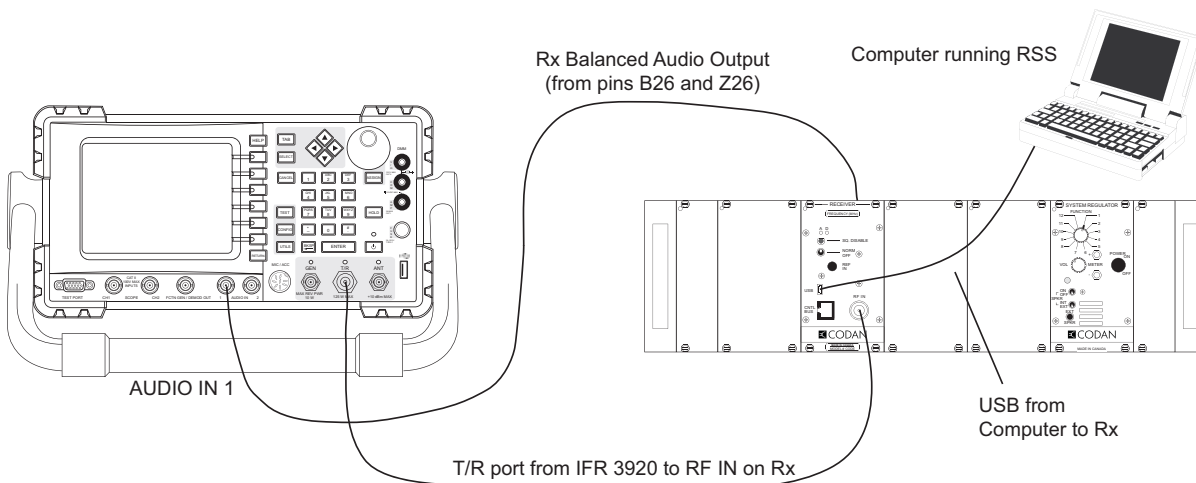

Figure C-3: Receiver Analog Testing

On the IFR 3920, recall Codan setup 01 (Rx Analog) from your internal drive. Enter the correct RF frequency and ensure that the deviation level of the 1.0 KHz tone is set correctly for your receiver (wide / narrow). Enter the correct CTCSS tone (if used) and deviation level for the tone. On the Codan Radio system, ensure the receiver is turned on and turn the System Regulator Speaker switch to ON and INT. Set the FUNCTION rotary switch to position 3 for Rx A or position 5 for Rx B (depending on the receiver being tested), then turn the volume up until the 1 KHz tone is audible.

In the Jumper Settings area of the Service section on the RSS, ensure that the “Subtones on audio path” selection is set to “Don’t pass” as shown in Figure C-4. The IFR 3920 will conduct all tests with CTCSS tones on the audio, giving erroneous measurements, if the Subtones are set to “Pass”.

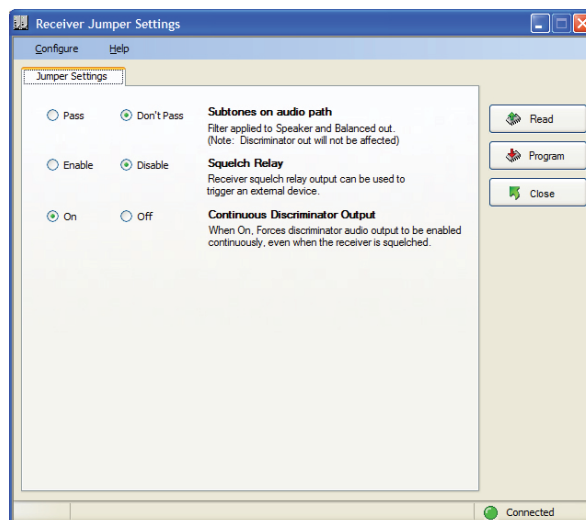

Figure C-4: RSS Subtone Settings

Audio Distortion:

To check receiver distortion, inject -70 dBm RF carrier level into the receiver and measure the audio distortion on the meter as shown in Figure C-5. The high limit is set to 2.0 %.

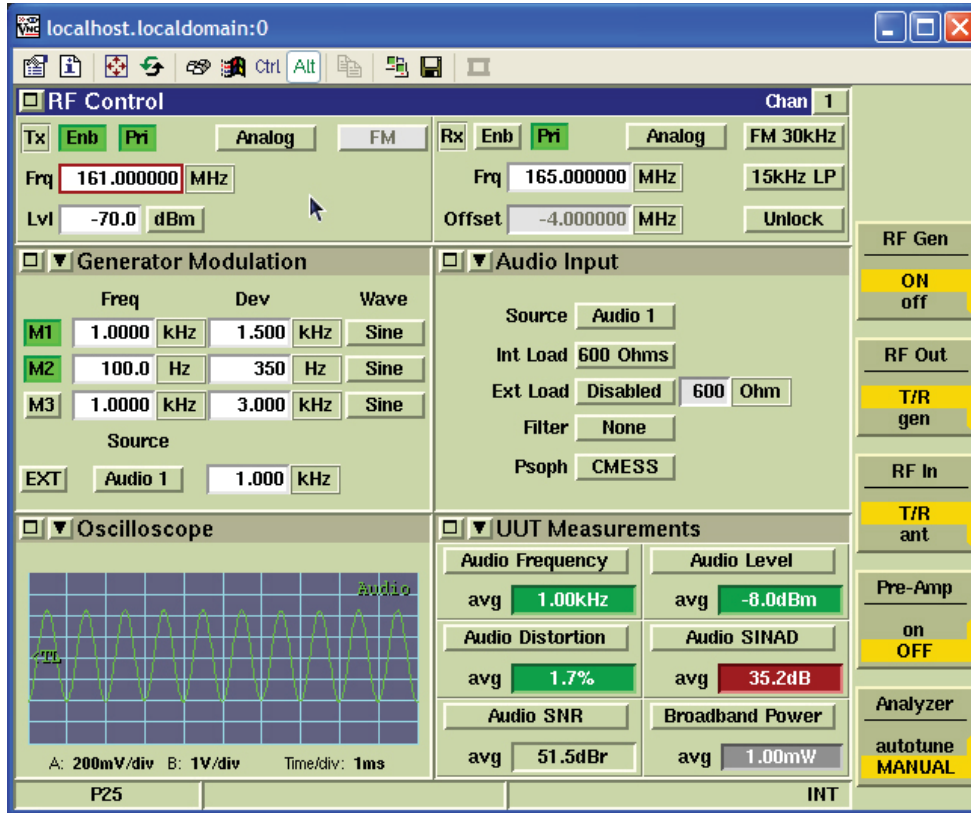

Figure C-5: Receiver Distortion Measurement

Enter the Audio Distortion reading on the MT-4E Test Sheet.

Reference Sensitivity:

To check receiver sensitivity, monitor the audio SINAD meter while slowly reducing the RF carrier level as shown in Figure C-6. The 12 dB SINAD point should be at an RF carrier level less than the specified Analog Sensitivity point of the receiver. The high and low limits are set at 11.5 dB and 12.5 dB SINAD.

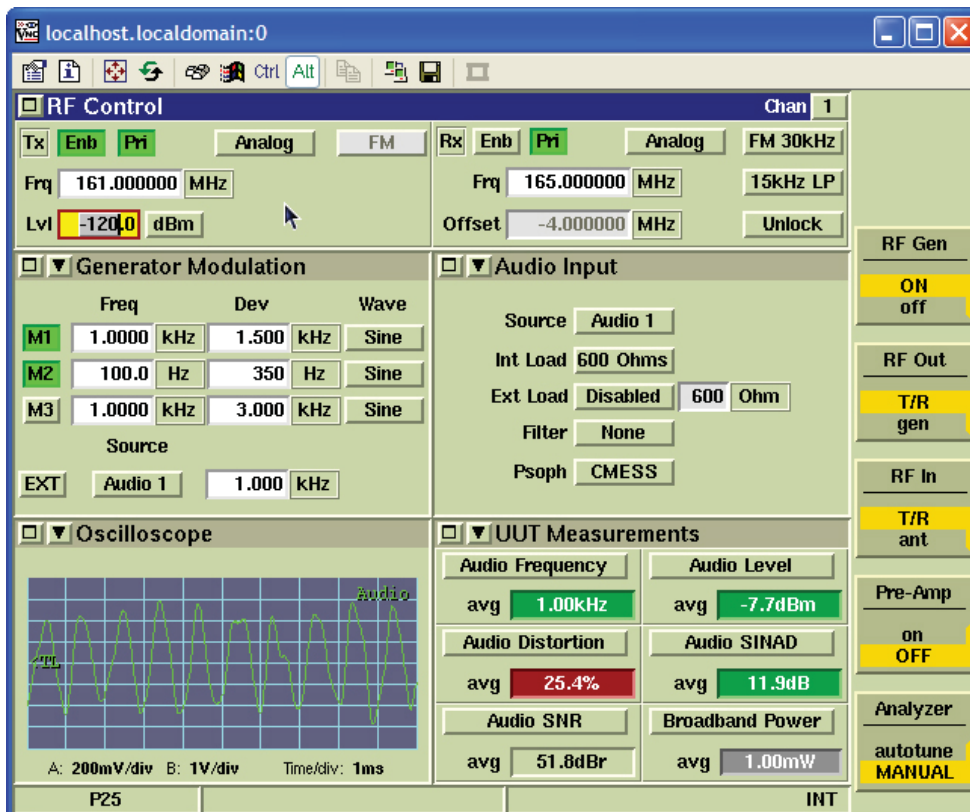

Figure C-6: Receiver Reference Sensitivity Measurement

Enter the Reference Sensitivity (12 dB SINAD) reading on the MT-4E Test Sheet.

If the distortion or reference sensitivity measurements are not within Codan published specifications, the RF Preselector may need re-alignment. Refer to the Receiver RF Preselector Alignment and Tuning section.

Squelch:

Adjust the RF carrier level up and down until the receiver squelches and unsquelches. There should be approximately 6.0 dBm of hysteresis between the squelch and unsquelch points. The squelch point can be adjusted in the Squelch Levels area of the Service section on the RSS.

The Receiver operates on a Noise based squelch (default) or a Received Signal Strength based squelch (optional). The squelch can be set globally for all channels, or on a per channel basis. To set the squelch Open and Close points, inject an RF signal at the desired Open or Close level and click the Set button.

Enter the Squelch and Unsquelch readings on the MT-4E Test Sheet.

Audio Level:

The audio level adjustment is not required when connecting the receiver in a repeater configuration using LVDS Serial Data. The audio level adjustment can be done on both the Rx Balanced Audio Output and the Auxiliary Balanced Output (1 and 2). The Auxiliary Balanced Output is only available on the AC-3E Control Card or CI-BC-4E Base Control Card.

To adjust the receiver balanced audio output, ensure that the AC-3E Control Card or CI-BC-4E Base Control Card is NOT plugged into the subrack, and inject -70 dBm RF carrier level into the receiver (no external load is required as the internal 600 ohm load of the IFR 3920 is used).

In the Audio Levels area of the Service section on the RSS, adjust the Rx Balanced Audio Output level adjustment as shown in Figure C-7 until -8.0 dBm audio level (0.308 Vrms @ 600 ohms) is measured on the Audio Level meter of the IFR 3920 as shown in Figure C-5. The high and low limits are set at -8.5 dBm and -7.5 dBm audio levels (these limits do not always load properly).

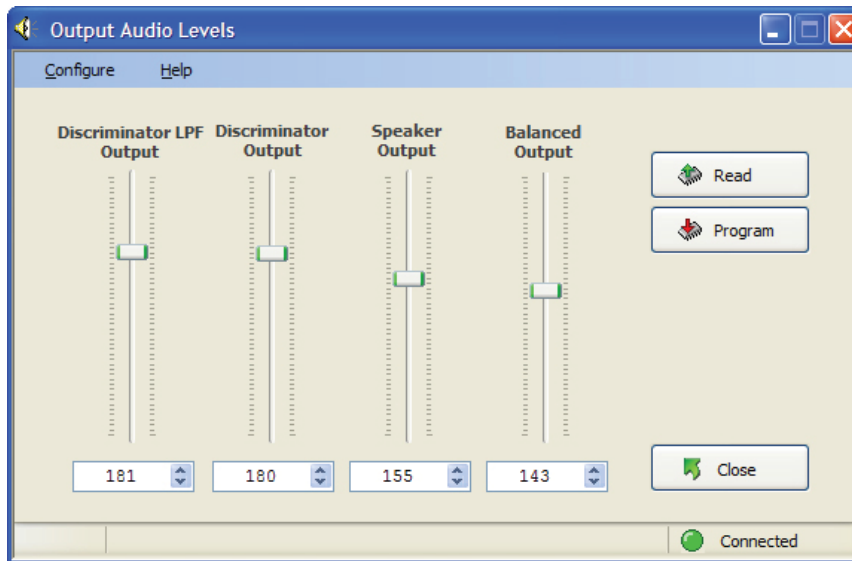

Figure C-7: RSS Receiver Audio Level Adjustment

To adjust the auxiliary balanced audio output, plug the AC-3E Control Card or CI-BC-4E Base Control Card into the subrack using an extender card and connect the Auxiliary Balanced audio output to the Audio In 1 input on the IFR 3920 (no external load is required as the internal 600 ohm load of the IFR 3920 is used). Auxiliary 1 audio output is available on pins B11 and A11, and Auxiliary 2 audio output is available on pins C1 and C3 for the AC-3E Control Card and pins C2 and C4 for the CI-BC-4E Base Control Card. Ensure that NO external devices (eg. tone remote adapter or IP router) are connected to the auxiliary audio output. Adjust the Auxiliary Balanced Audio Output level adjustment (R13 for Aux Out 1, R56 for Aux Out 2) for 0.0 dBm audio level (0.775 Vrms @ 600 ohms).

Enter the Balanced Audio Output Level and Auxiliary Audio Output Level (if used) readings on the MT-4E Test Sheet.

There are no specific measurements to check Receive CTCSS, just verify that the receiver CTCSS is operating.

Receiver Digital Testing

Connect the IFR 3920 and Codan Radio as shown in Figure C-8.

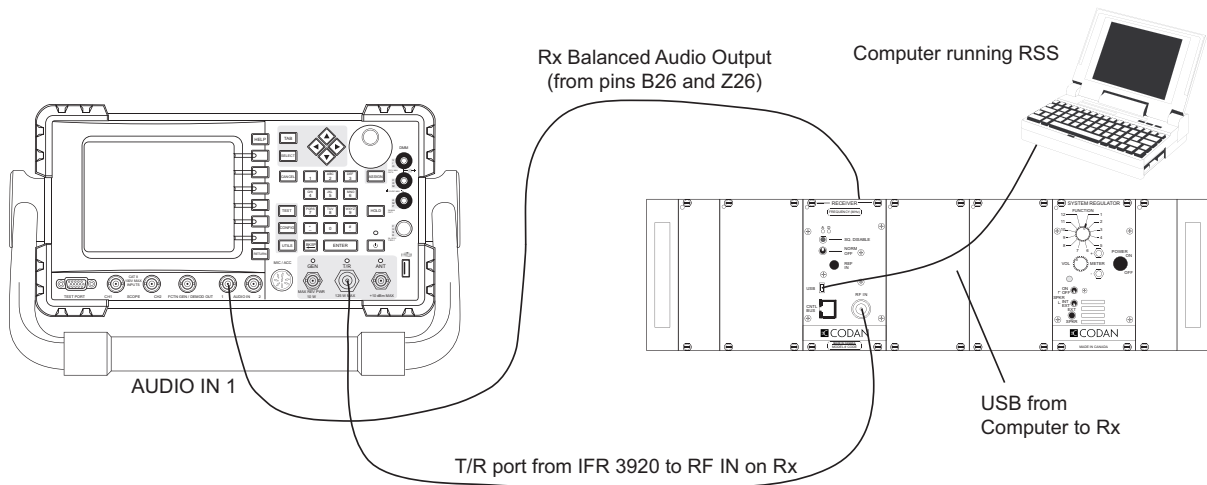

Figure C-8: Receiver Digital Testing

On the IFR 3920, recall Codan setup 02 (Rx Digital) from your internal drive. Enter the correct RF frequency, and ensure that the RF Control is set to Phase 1 and it is set for the STORED SPCH test pattern (or optionally the 1011 test pattern).

Inject the correct NAC (and TGID if programmed) and ensure that the receiver is operating as shown in Figure C-9. There are no specific measurements to make on this test, just verify that the receiver is operating.

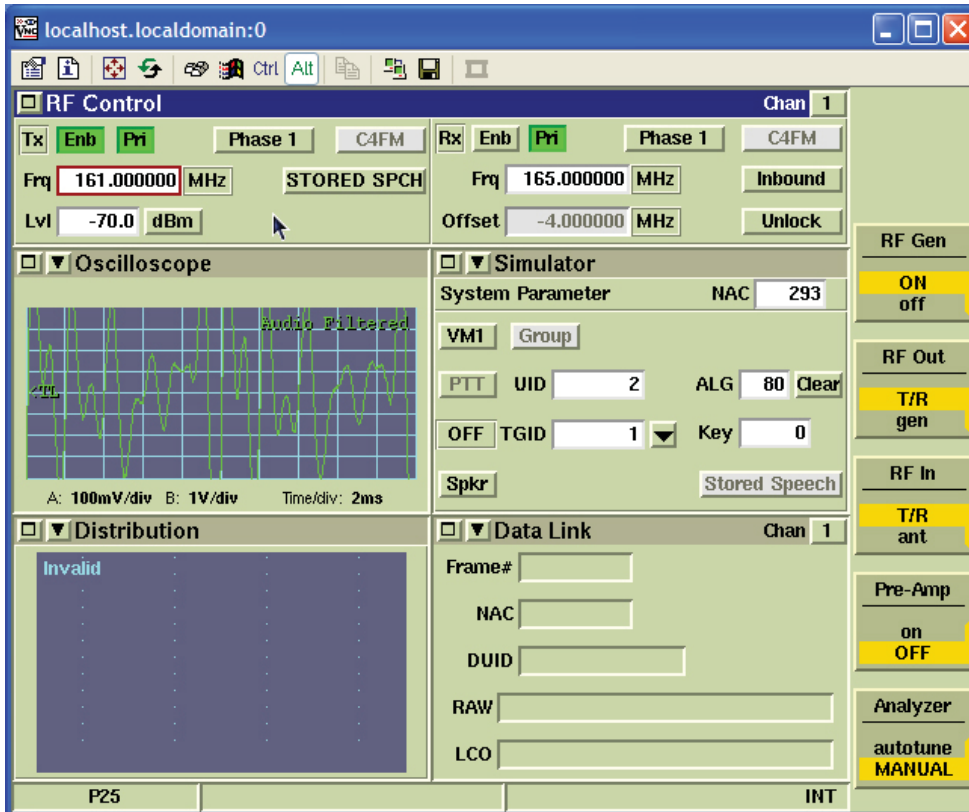

Figure C-9: Receiver Digital Check

Receiver Bit Error Rate Testing

Connect the IFR 3920 and Codan Radio as shown in Figure C-10.

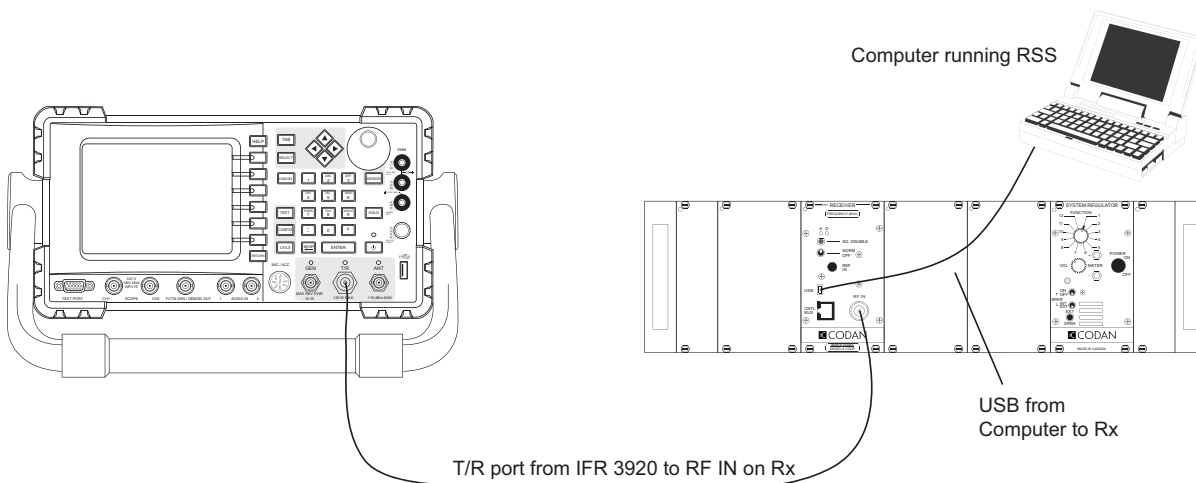

Figure C-10: Receiver Bit Error Rate Testing

On the IFR 3920, recall Codan setup 02 (Rx Digital) from your internal drive. Enter the correct RF frequency, and ensure that the RF Control is set to Phase 1 and it is set for the STD 1011 test pattern (the 1011 test pattern will not operate correctly for this test) as shown in Figure C-11.

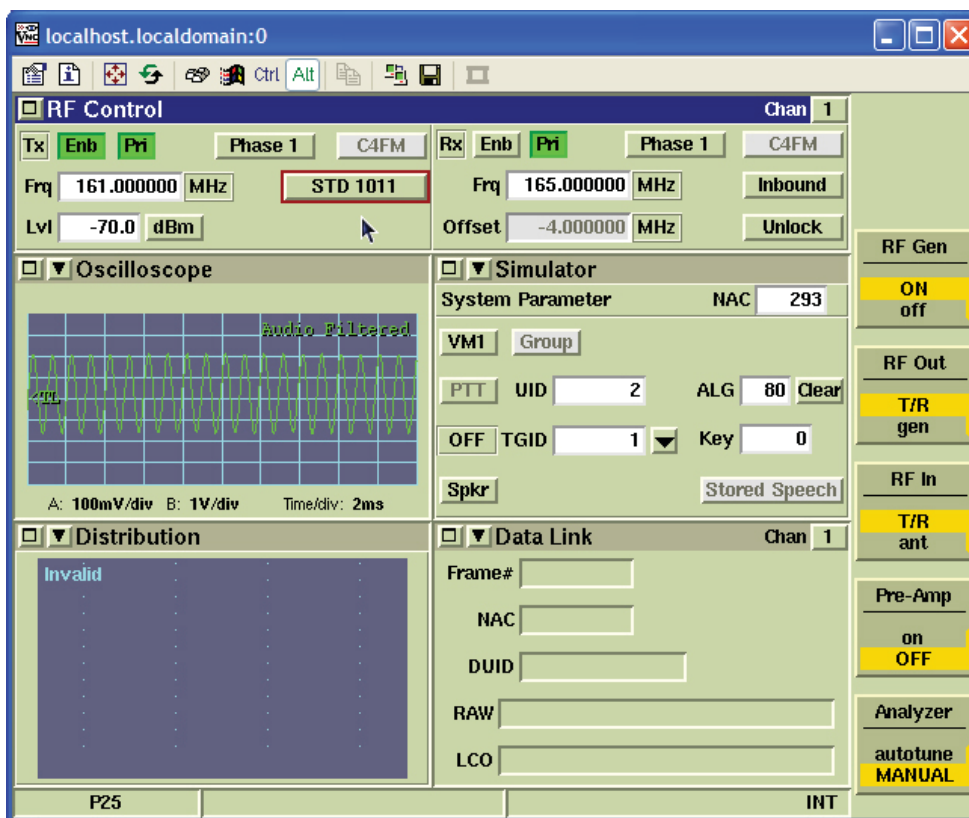

Figure C-11: Receiver Bit Error Rate Test Injection

In the receiver RSS, enter the Service section and click on “Bit Error Rate”. The receiver frequency should automatically be shown in the frequency box. Select the Test Type to “Continuous” and Avg. Superframes to “8”. Click on the “Start Test” button to start the BER test. You should get 0% BER at the -70 dBm default RF carrier level.

Monitor the BER reading while slowly reducing the RF carrier level as shown in Figure C-12. The 5% BER point should be at an RF carrier level less than the specified Digital Sensitivity point of the receiver.

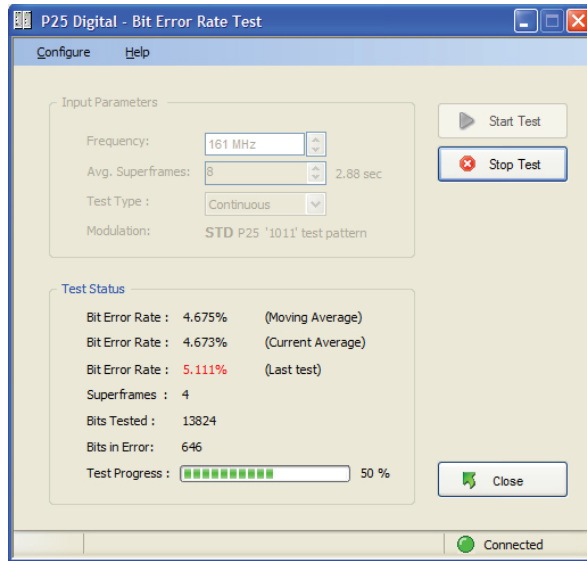

Figure C-12: RSS Receiver Bit Error Rate Test

Enter the Reference Sensitivity (5% BER) reading on the MT-4E Test Sheet.

If the BER measurements are not within Codan published specifications, the RF Preselector may need re-alignment. Refer to the Receiver RF Preselector Alignment and Tuning section.

Receiver RF Preselector Alignment and Tuning

Tuning of the RF Preselector filter is typically only required when the Analog or Digital Sensitivity or Analog Distortion do not meet published specifications, or when the receiver RF frequency is changed beyond the band pass of the filter (typically 5 - 7 MHz in a VHF or UHF 400 MHz receiver). The UHF 700 / 800 / 900 MHz receiver RF Preselector is Full Band and does not require any tuning.

Connect the IFR 3920 and Codan Radio as shown in Figure C-13.

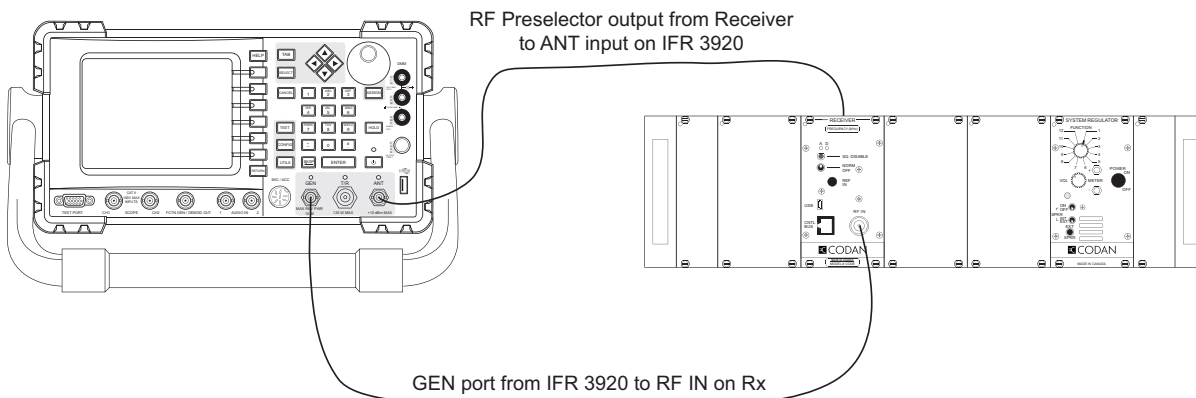

Figure C-13: Receiver RF Preselector Tuning

The RF Preselector output is a small RF cable internal in the receiver that terminates in an SMB connector. The SMB plugs into J3 on the Receiver Mainboard. Disconnect the SMB cable from J3 and use the SMB-BNC adapter to connect this point to the ANT input on the IFR 3920 as shown in Figure C-14.

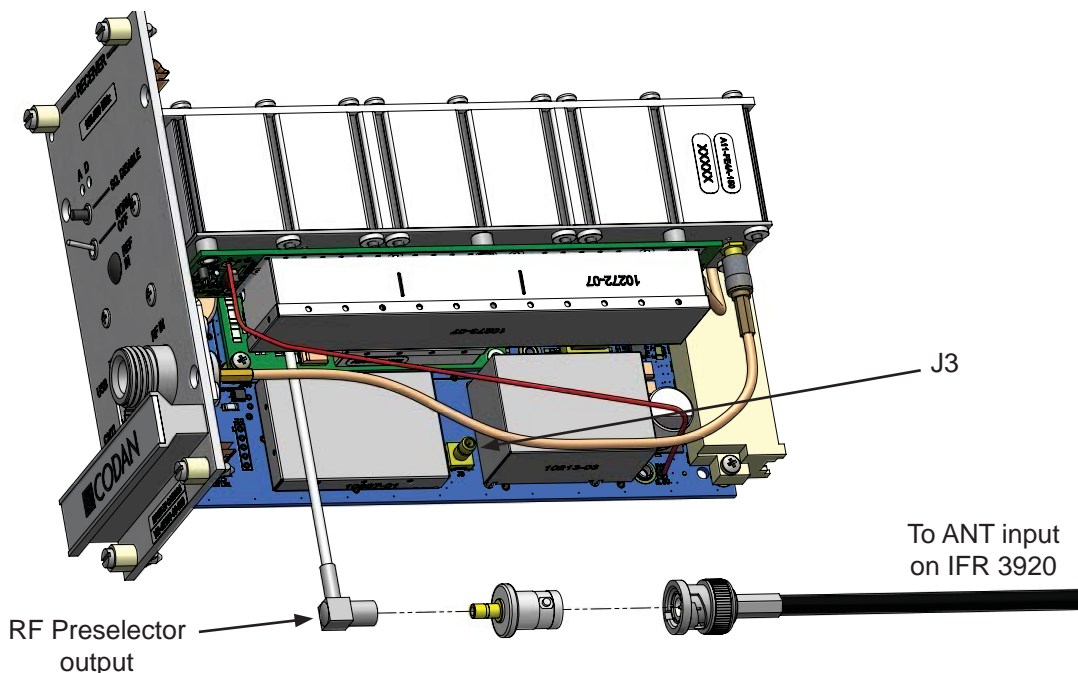

Figure C-14: Receiver RF Preselector Connection

On the IFR 3920, recall Codan setup 03 (Rx Preselector Tune) from your internal drive. If Trk Gen does not appear on the lower left corner of the display, then the IFR 3920 does not have the tracking generator option. Enter the correct RF frequency as the Center Frequency (CF) and ensure the receiver is turned on. The filter waveform should appear as shown in Figure C-15. Turn the Markers on to add optional markers to the spectrum analyzer if desired.

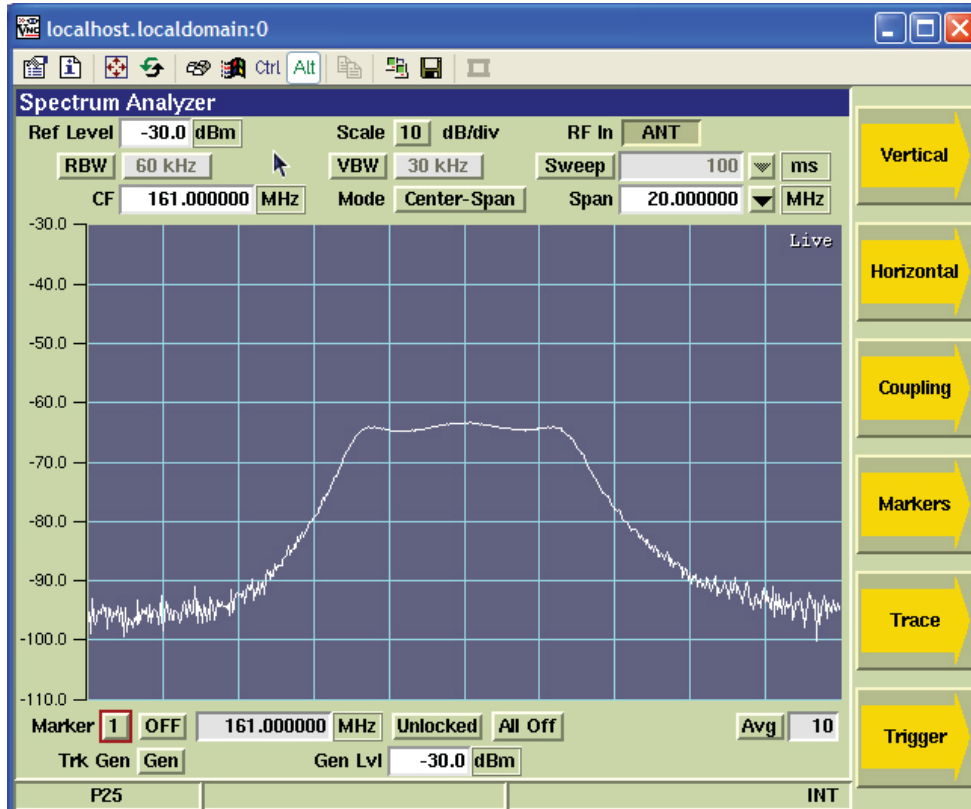

Figure C-15: Receiver RF Preselector on the Spectrum Analyzer

To tune the RF Preselector filter, remove the dust caps on the variable capacitors and, starting from the capacitor closest to the front panel of the receiver and moving back, tune the filter to its new frequency.

Receiver Reference Oscillator Adjustment

Connect the IFR 3920 and Codan Radio as shown in Figure C-16.

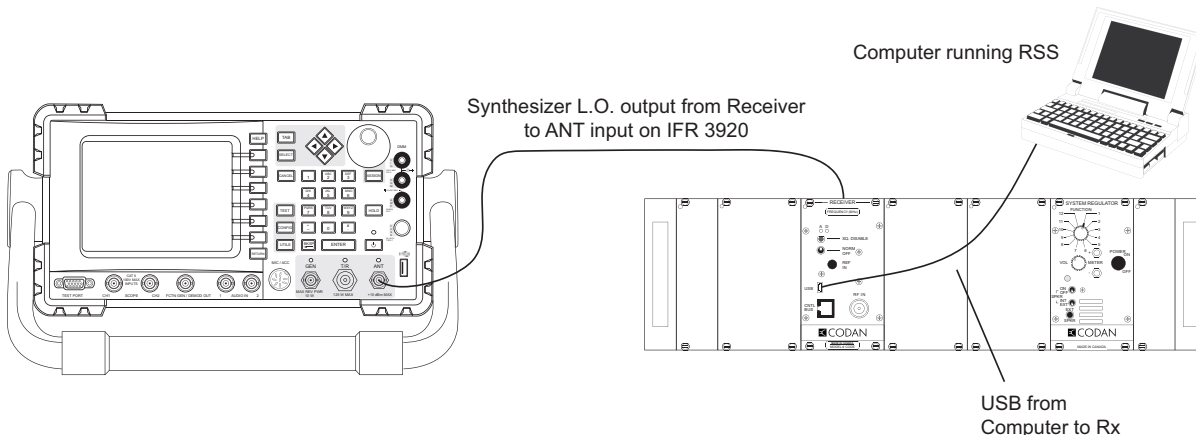

Figure C-16: Receiver Reference Oscillator Testing

The reference oscillator test on the receiver requires a connection directly into the Synthesizer, which uses an SMB connector. Disconnect the SMB cable from the LO output of the synthesizer and connect the small SMB-SMB cable to the SMB jack that is mounted on the Synthesizer (beneath the RF Preselector). The SMB-BNC adapter is required to connect this point to the ANT input on the IFR 3920 as shown in Figures C-17 (VHF and UHF 400 MHz Receiver) and C-18 (UHF 700 / 800 / 900 MHz Receiver).

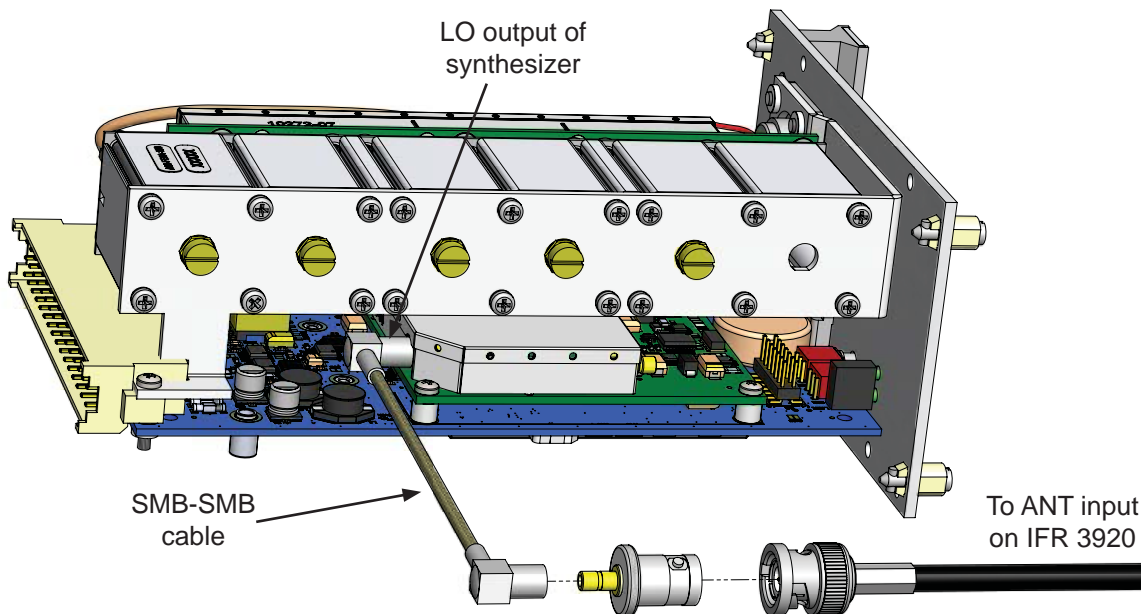

Figure C-17: VHF and UHF 400 MHz Receiver Reference Oscillator Connection

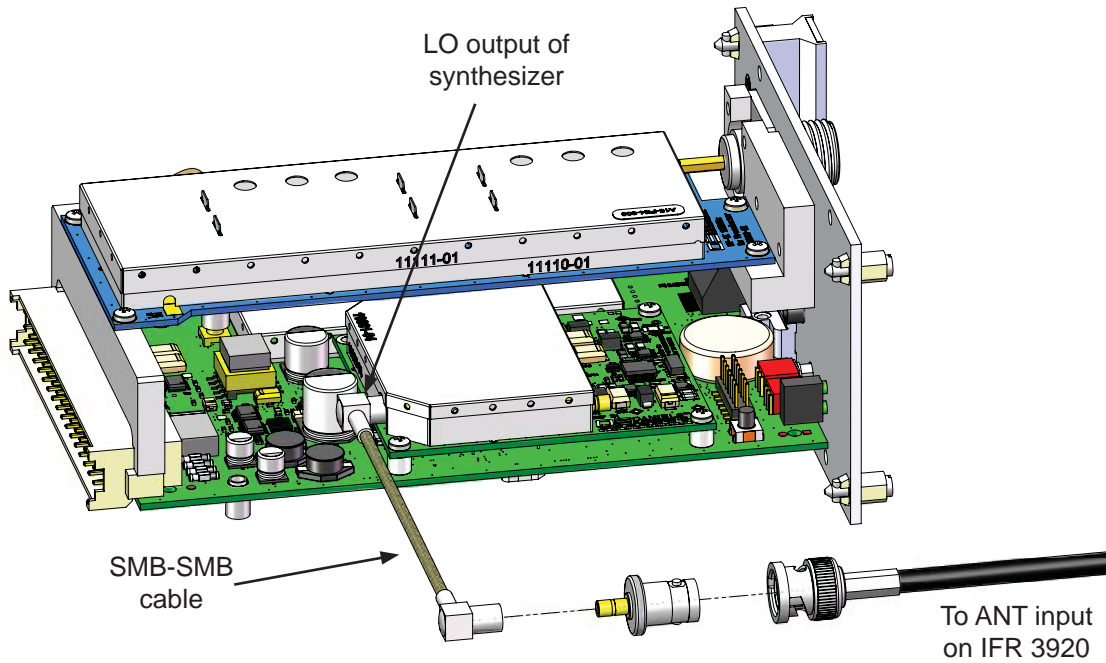

Figure C-18: UHF 700 / 800 / 900 MHz Receiver Reference Oscillator Connection

On the IFR 3920, recall Codan setup 04 (Rx Reference) from your internal drive as shown in Figure C-19.

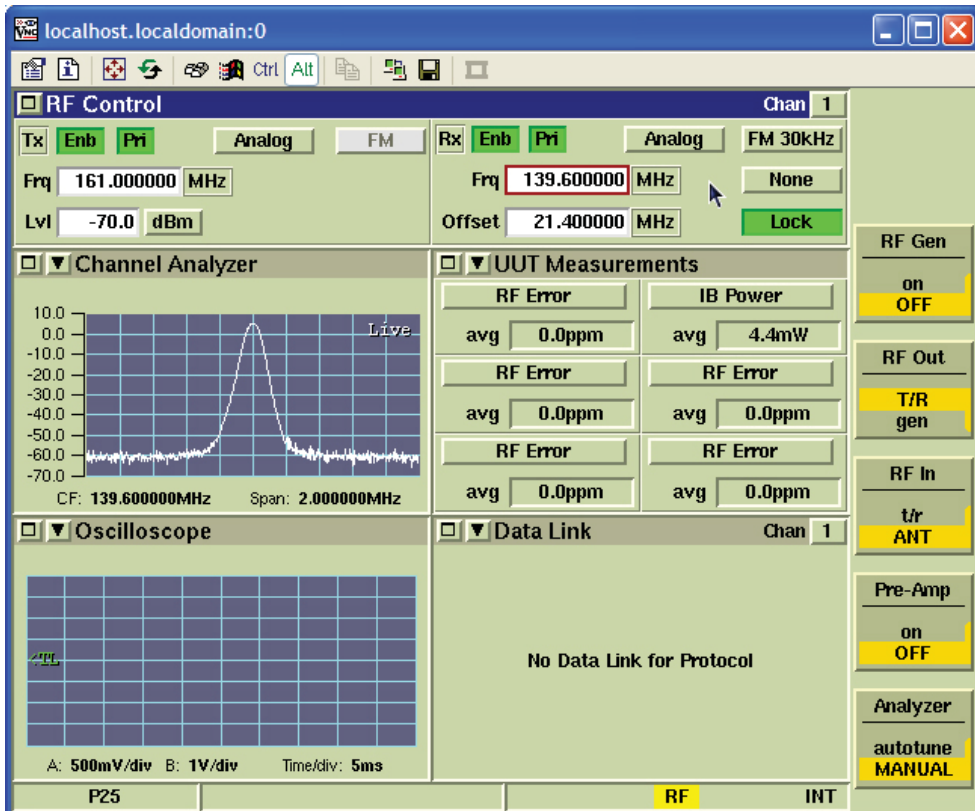

Figure C-19: Receiver Reference Oscillator Measurement

In the receiver RSS, enter the Service section and click on “Ref Oscillator”. The reference oscillator frequency is shown as the “Target Synthesizer RF OUT”. Enter this RF frequency into the Analyzer RF Freq on the IFR 3920. The receiver generates this frequency out of the Synthesizer into the IFR 3920.

Monitor the Freq Offset on the IFR 3920. To change the reference frequency, adjust the softpot slider in the RSS as shown in Figure C-20. Adjust until the RF error is as close to 0 Hz (or 0 ppm) as possible. Click on the “Program” button to program in the new Reference Oscillator softpot value.

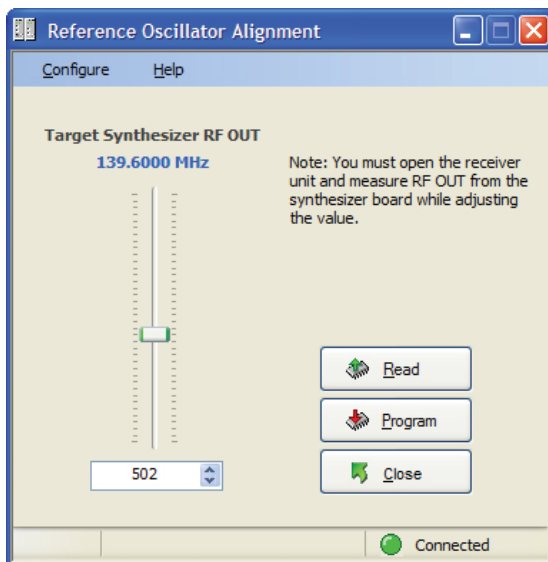

Figure C-20: RSS Receiver Reference Oscillator Alignment

Enter the L.O. Reference Oscillator Offset reading on the MT-4E Test Sheet.

TRANSMITTER TESTING

Transmitter Analog Testing

Connect the IFR 3920 and Codan Radio as shown in Figure C-21.

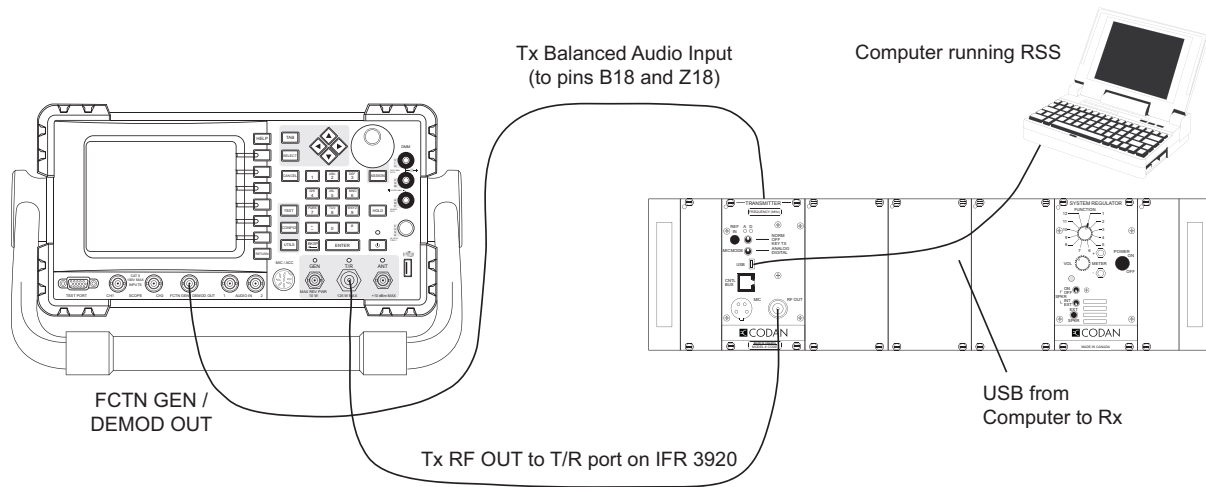

Figure C-21: Transmitter Analog Testing

On the IFR 3920, recall Codan setup 05 (Tx Analog) from your internal drive. Enter the correct RF frequency on the IFR 3920, set the MIC MODE switch on the front panel of the transmitter to Analog, and flip the other switch to KEY TX (or set the switch to NORM and key the transmitter through the RSS).

Audio Generator 1 is configured to inject a 1.0 KHz tone at -8.0 dBm (0.308 Vrms) into the transmitter balanced input.

Audio Distortion:

The distortion meter will read demodulated audio and give you a transmitter demod distortion reading as shown in Figure C-22. The high limit is set to 3.0 %.

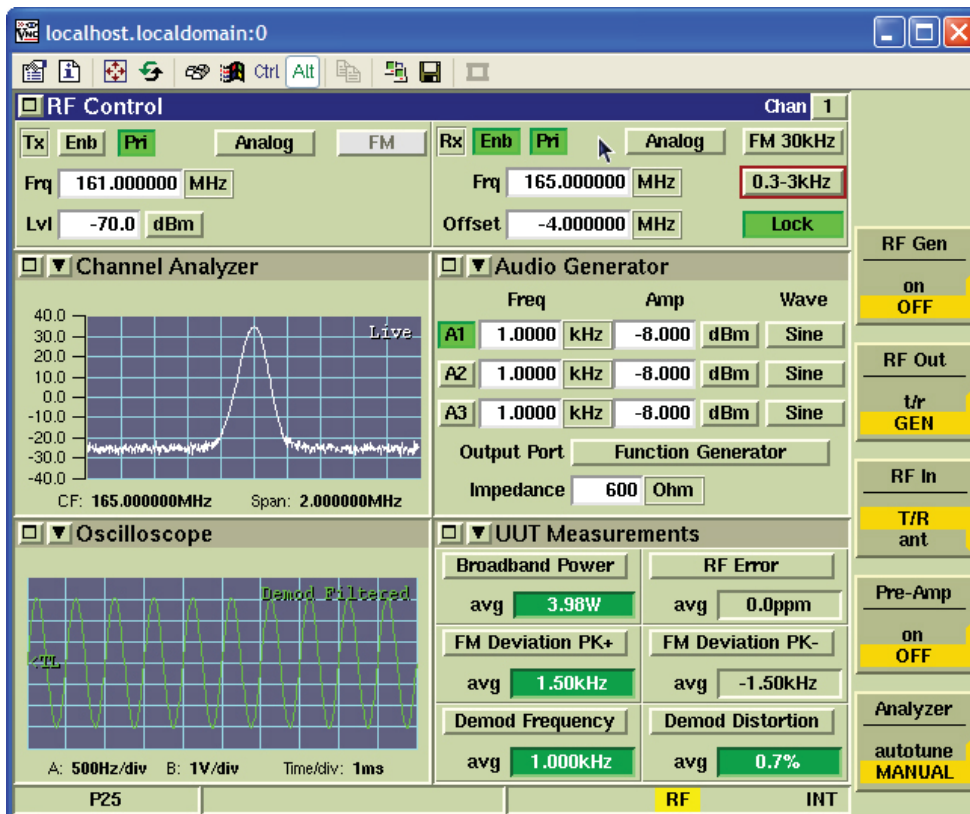

Figure C-22: Transmitter Distortion and Power Measurements

Enter the Audio Distortion reading on the MT-4E Test Sheet.

RF Power:

Monitor the RF power output of the transmitter as shown in Figure C-22. In the Power Level area of the Service section on the RSS, click on the “Key Tx” button and adjust the Transmitter Output Power adjustment as shown in Figure C-23 to change the RF output power. The high limit is set at 8.5 Watts and the low limit is set at 0.5 Watts. Transmitter RF power output will vary slightly with the +10 - +17 Vdc input.

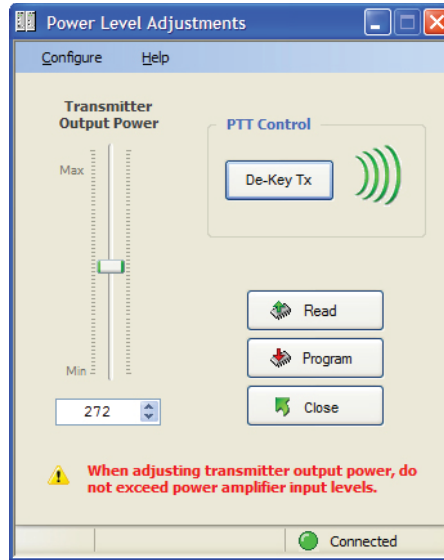

Figure C-23: RSS Transmitter Power Level Adjustment

Enter the RF Power Output reading on the MT-4E Test Sheet.

Connect the transmitter to the power amplifier (if used) and measure the RF power output of the amplifier. Do not exceed power amplifier input levels.

Enter the Amplifier RF Power Output reading on the MT-4E Test Sheet.

Deviation Level:

The deviation level adjustment is not required when connecting the transmitter in a repeater configuration using LVDS Serial Data. The audio level / deviation level adjustment can be done on both the Tx Balanced Audio Input and the Auxiliary Balanced Input (1 and 2). The Auxiliary Balanced Input is only available on the AC-3E Control Card or CI-BC-4E Base Control Card.

Change the Audio Filter (top right corner) from 0.3-3KHz to 15 KHz LP as shown in Figure C-24 for a more accurate deviation reading without CTCSS encode. If the transmitter has CTCSS encode, leave the Audio Filter on 0.3-3KHz.

To adjust the transmitter balanced input, ensure that the AC-3E or CI-BC-4E Control Card is NOT plugged into the subrack. Audio Generator 1 is configured to inject a 1.0 KHz tone at -8.0 dBm (0.308 Vrms) into the Tx Balanced audio input.

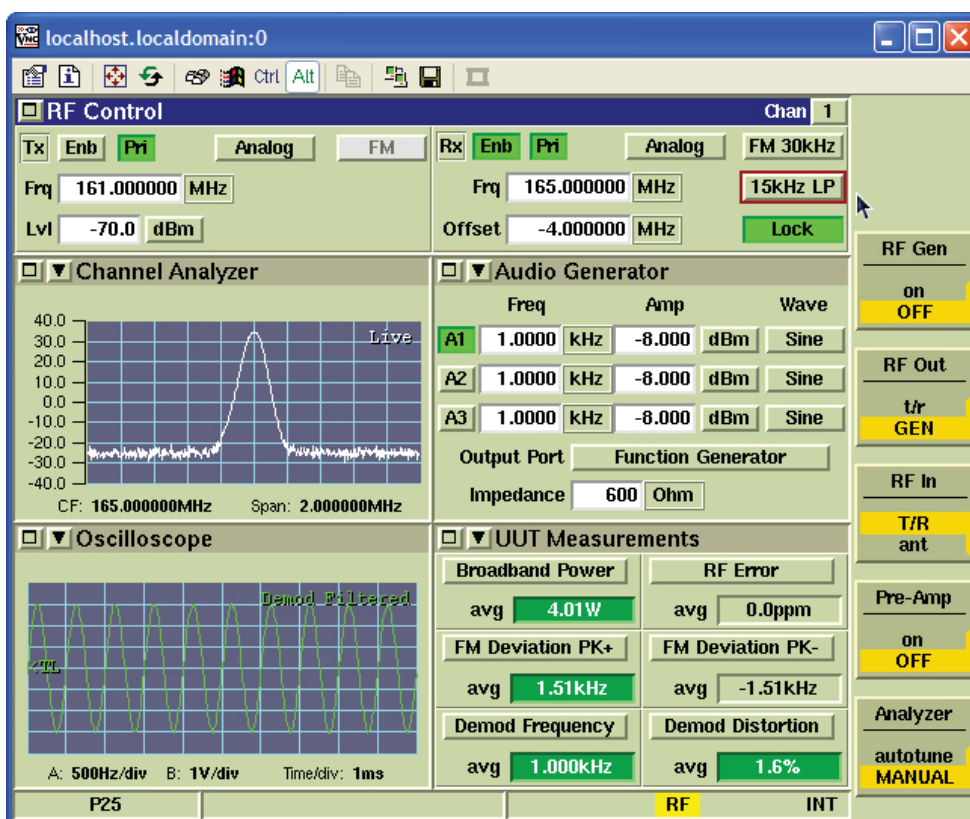

Figure C-24: Transmitter Deviation Measurement

In the Deviation Levels area of the Service section on the RSS, click on the “Key Tx” button and adjust the Tx Balanced Audio Input level adjustment as shown in Figure C-25 until a deviation of +/- 1.5 KHz (narrowband) or +/-3.0 KHz (wideband) is measured on the IFR 3920. The high and low limits are set at +/-1.4 KHz to +/- 1.6 KHz deviation (on the deviation + side only).

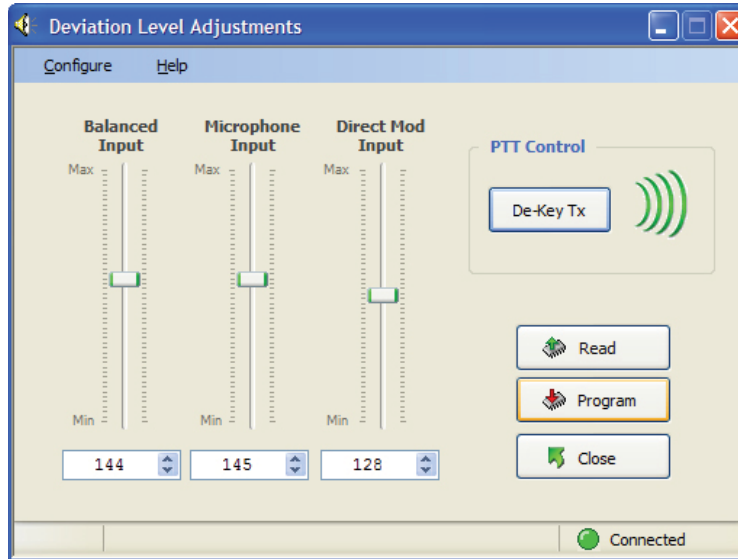

Figure C-25: RSS Transmitter Audio Level Adjustment

Enter the Transmitter Deviation Level reading on the MT-4E Test Sheet.

Configure Audio Generator 1 to inject a 300 Hz tone at +10.0 dBm (2.500 Vrms) into the Tx Balanced audio input and adjust the audio frequency from 300 Hz to 3400 Hz in increments of 100 Hz and check that the transmitter deviation does not rise above +/- 2.5 KHz (narrowband) or +/-5.0 KHz (wideband). The MT-4E Transmitter will transmit a maximum deviation at an audio frequency of approximately 1300 Hz.

Enter the Transmitter Maximum Deviation Level reading on the MT-4E Test Sheet.

To adjust the auxiliary balanced audio input, plug the AC-3E Control Card or CI-BC-4E Base Control Card into the subrack using an extender card, disconnect the Tx Balanced audio input and connect the Auxiliary Balanced audio input to the FCTN GEN / DEMOD OUT on the IFR 3920. Auxiliary 1 audio input is available on pins C19 and C20, and Auxiliary 2 audio input is available on pins B14 and A14. Ensure that NO external devices (eg. tone remote adapter or IP router) are connected to the auxiliary audio input. Configure FGEN1 to inject a 1.0 KHz tone at 0.0 dBm (0.775 Vrms) into the Auxiliary Balanced audio input. Adjust the Auxiliary Balanced Audio Input level adjustment (R120 for Aux In 1, R123 for Aux In 2) for deviation of +/- 1.5 KHz (narrowband) or +/-3.0 KHz (wideband). The high and low alarms are set at +/-1.4 KHz to +/- 1.6 KHz deviation (on the deviation + side only)..

Enter the Auxiliary Deviation Level (if used) reading on the MT-4E Test Sheet.

Reference Oscillator Adjustment

In the transmitter RSS, enter the Service section and click on “Ref Oscillator”. The reference oscillator frequency is shown as the “Target Frequency”. Enter this RF frequency into the IFR 3920. Click on the “Key Tx” button and the transmitter will generate the reference frequency out of the RF output into the IFR 3920.

Monitor the RF Offset on the IFR 3920. To change the reference frequency, adjust the softpot slider in the RSS as shown in Figure C-26.

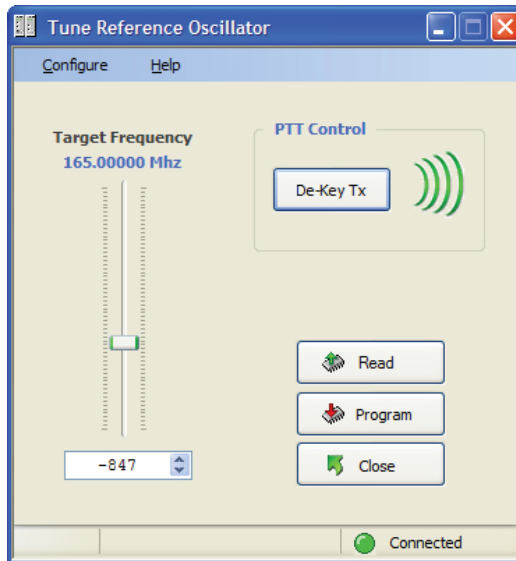

Figure C-26: RSS Transmitter Reference Oscillator Alignment

Adjust until the RF Offset is as close to 0 Hz as possible. Click on the “Program” button to program in the new Reference Oscillator softpot value.

Enter the Carrier Reference Oscillator Offset reading on the MT-4E Test Sheet.

Transmitter CTCSS Testing

MT-4E Transmitters can be programmed, per channel, to generate CTCSS tones internally, or to allow for External Input of the CTCSS tones from another device (such as a tone-remote adapter).

Connect the IFR 3920 and Codan Radio as shown in Figure C-27. The Tx Subtone input connection is only required when testing the External Input. If the internal programming is used to generate the CTCSS tone, disconnect the Tx Subtone input from the IFR 3920.

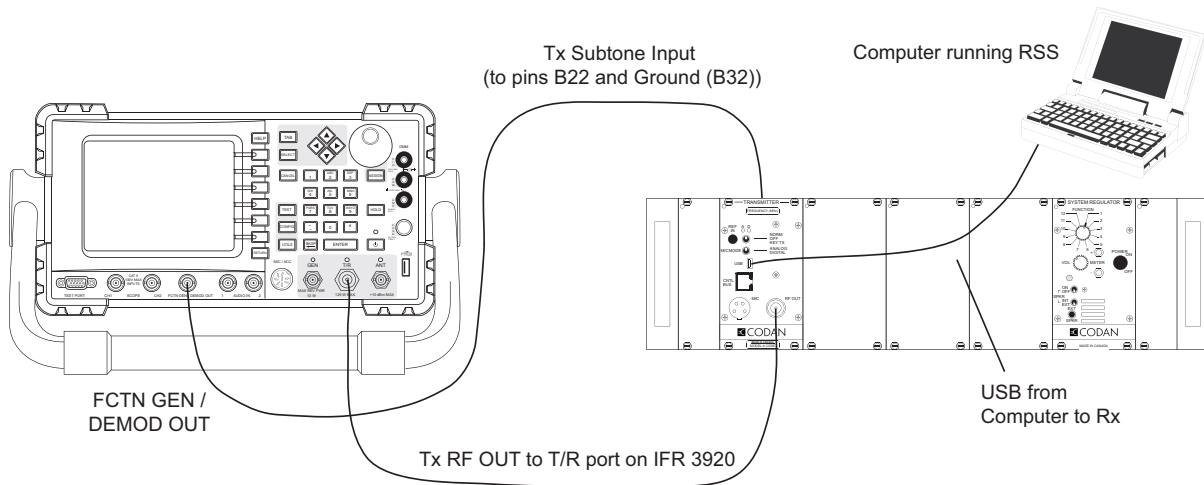

Figure C-27: Transmitter CTCSS Testing

On the IFR 3920, recall Codan setup 06 (Tx CTCSS) from your internal drive. Enter the correct RF frequency on the IFR 3920, set the MIC MODE switch on the front panel of the transmitter to Analog and flip the other switch to KEY TX (or set the switch to NORM and key the transmitter through the RSS).

Audio Generator 2 (if used) is configured to inject a 100 Hz tone at -18.0 dBm (0.098 Vrms or 0.277 Vpp) into the Tx Subtone input as shown in Figure C-28. If the internal programming is used to generate the CTCSS tone, the Audio Generators are not used and the CTCSS tone is generated internally in the transmitter.

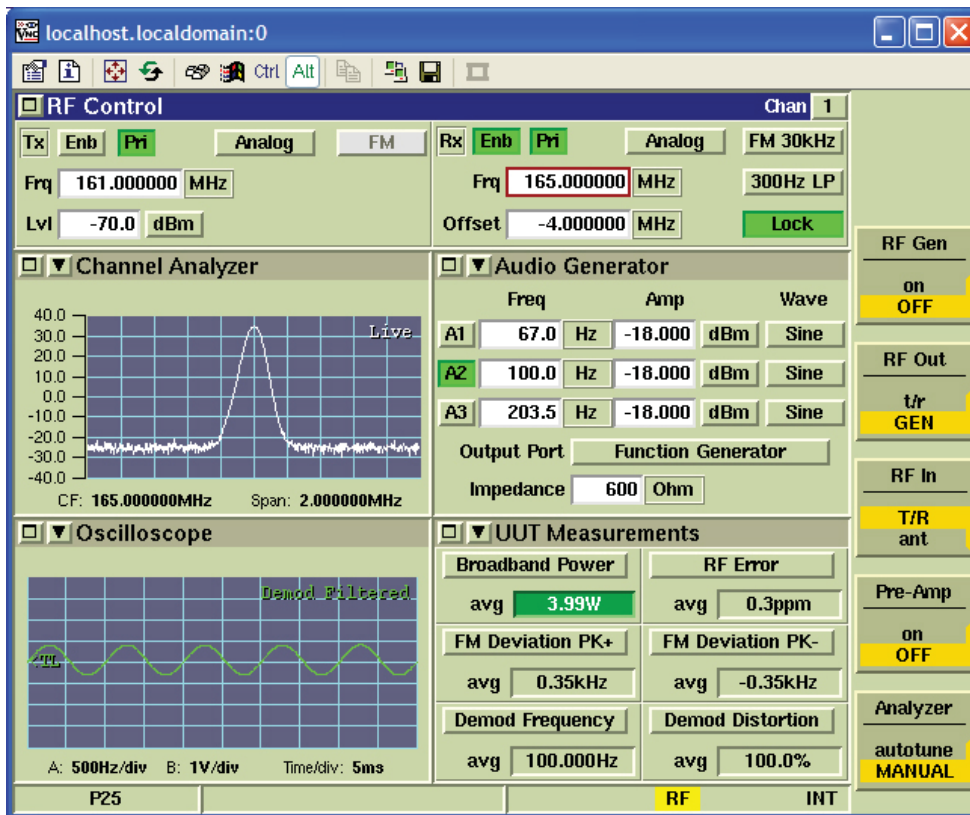

Figure C-28: Transmitter CTCSS Tone and Deviation Measurement

In the Subtone Levels area of the Service section on the RSS, click on the “Key Tx” button and adjust the Narrow and/or Wide Internal and/or External Subtone Deviation level adjustment as shown in Figure C-29 until a deviation of +/- 0.35 KHz (narrowband) or +/-0.5 KHz (wideband) is measured on the IFR 3920. There are no high and low limits.

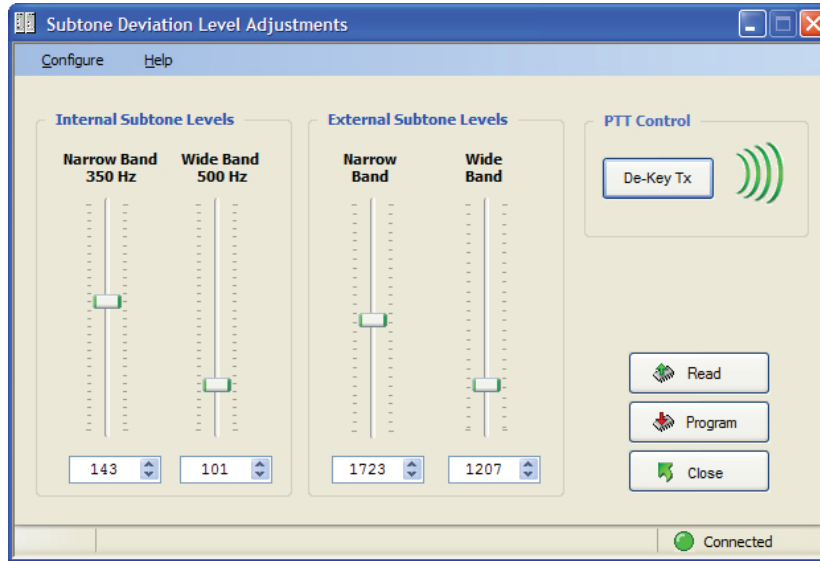

Figure C-29: RSS Transmitter Subtone Deviation Level Adjustment

Enter the CTCSS Encode Deviation level reading on the MT-4E Test Sheet.

Transmitter Digital Testing

Connect the IFR 3920 and Codan Radio as shown in Figure C-30.

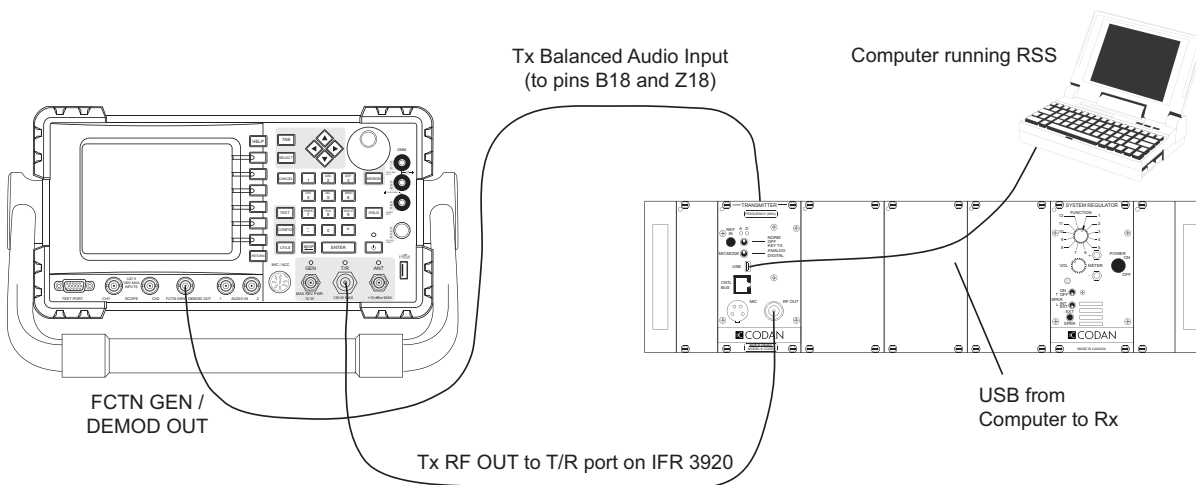

Figure C-30: Transmitter Digital Testing

On the IFR 3920, recall Codan setup 07 (Tx Digital) from your internal drive as shown in Figure C-31. Enter the correct RF frequency on the IFR 3920, set the MIC MODE switch on the front panel of the transmitter to Digital and flip the other switch to KEY TX (or set the switch to NORM and key the transmitter through the RSS).

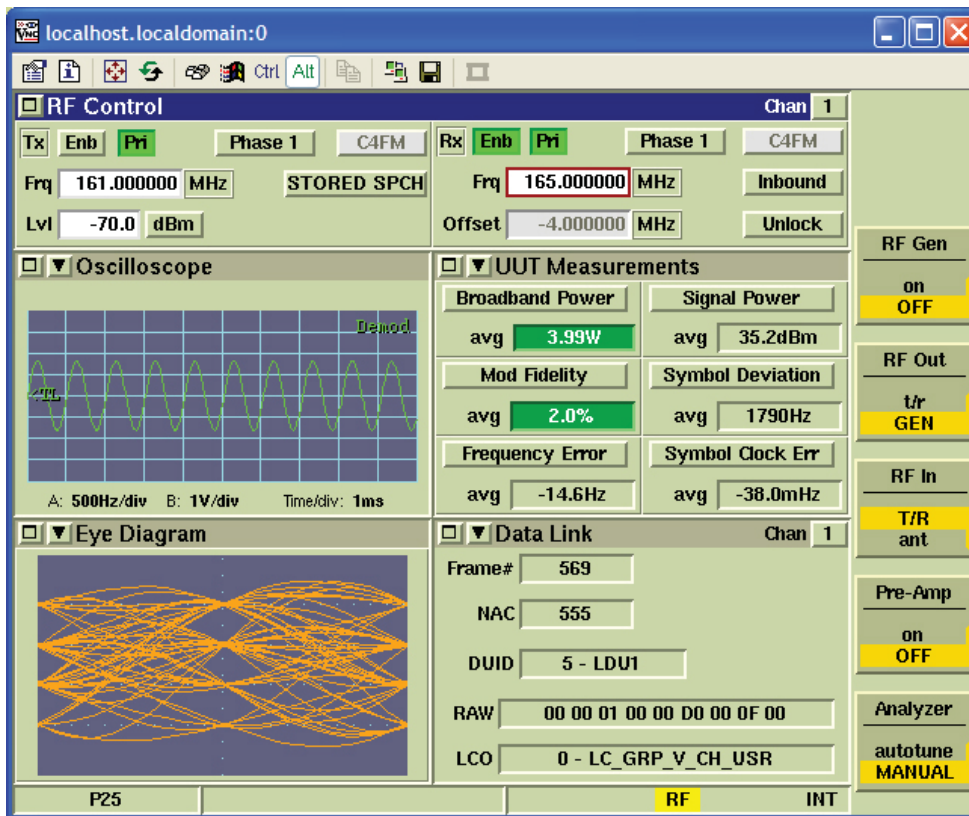

Figure C-31: Transmitter Digital Check

Audio Generator 1 is configured to inject a 1.0 KHz tone at -8.0 dBm (0.308 Vrms) into the transmitter balanced input. A continuous tone injected into the transmitter will be demodulated as a “fluctuating” audio level and tone on older P25 radio systems. Optionally, a microphone can be connected to the front panel of the transmitter and the tester can speak into the microphone and listen to the demodulated audio on the IFR 3920.

Click on the Data Link menu expansion to show all of the P25 Data Link information. Ensure the correct NAC, TGID and Unit ID are being transmitted properly as shown in Figure C-32. The NAC, TGID and Unit ID are all programmed into the transmitter via the RSS. There are no specific measurements to make on this test, just verify that the transmitter is operating.

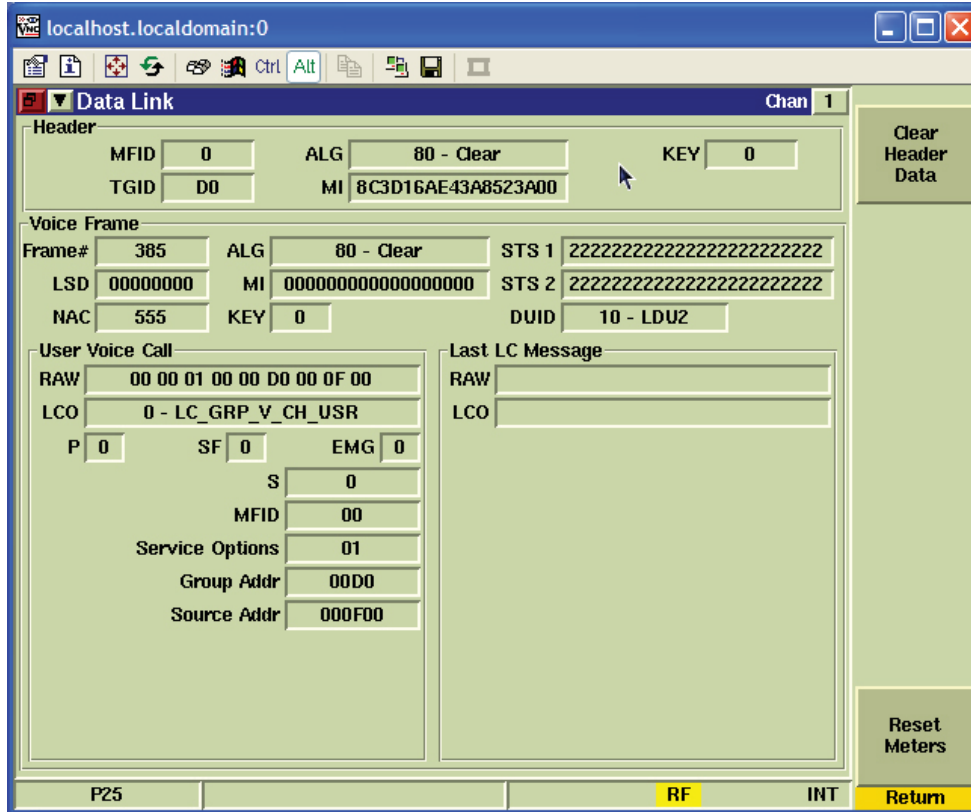

Figure C-32: Transmitter Data Link Check

Modulation Fidelity Testing

In the transmitter RSS, enter the Service section and click on “Test Patterns”. Ensure the transmitter frequency is in the frequency box. In the Select Pattern window select “C4FM Modulation Fidelity”. Click on the “Key Tx” button as shown in Figure C-33 and the transmitter will begin generating the test pattern out the RF output.

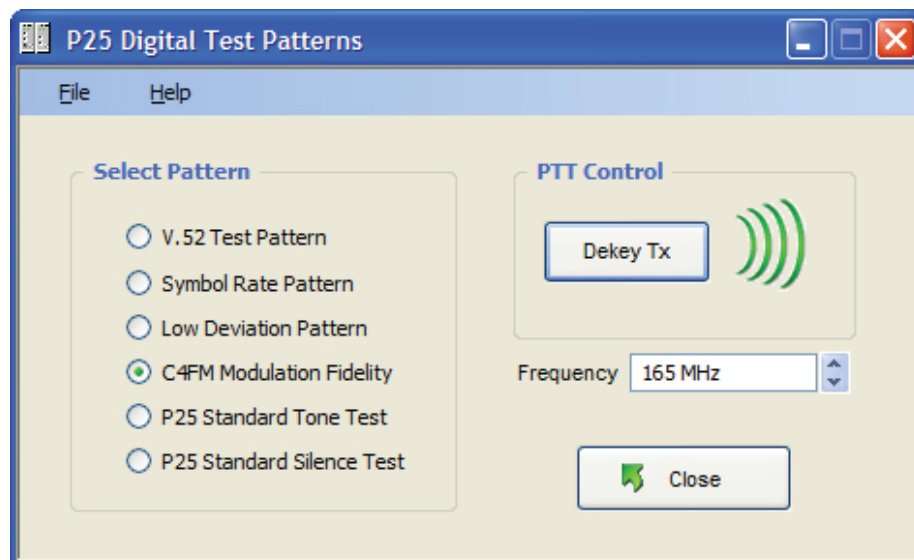

Figure C-33: RSS Transmitter Modulation Fidelity Test Pattern

Measure the Modulation Fidelity of the transmitter as shown in Figure C-34. The transmitter should not read more than 5% Modulation Fidelity. If the Modulation Fidelity is more than 5%, the transmitter will need to be returned to the factory for service.

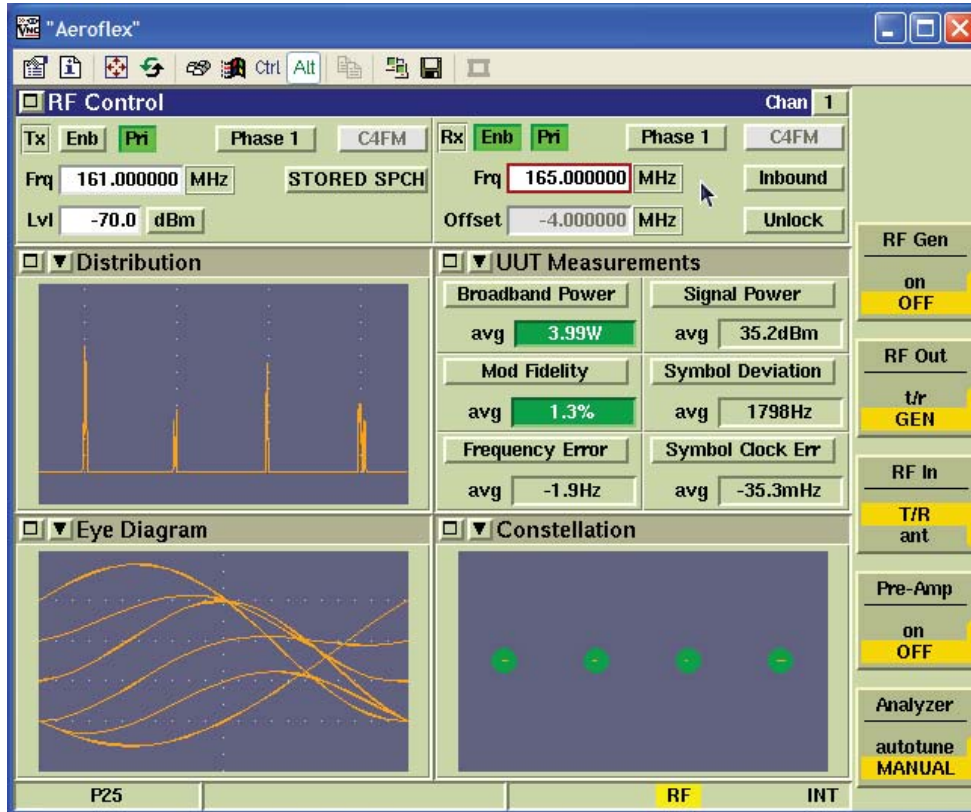

Figure C-34: Transmitter Modulation Fidelity Measurement

Enter the C4FM Modulation Fidelity reading on the MT-4E Test Sheet.

SYSTEM TESTING

Duplex Analog Testing

Connect the IFR 3920 and Codan Radio as shown in Figure C-35:

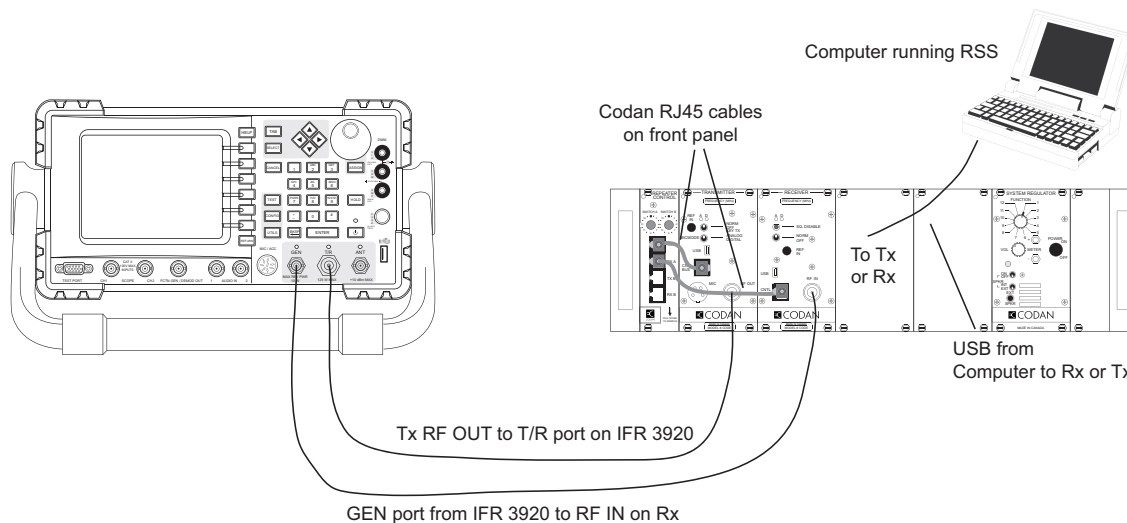

Figure C-35: System Duplex Analog Testing

On the IFR 3920, recall Codan setup 08 (Duplex Analog) from your internal drive as shown in Figure C-36. Enter the correct RF frequencies for the receiver and transmitter and ensure that the deviation level of the 1.0 KHz tone is set correctly for your receiver (wide / narrow). Enter the correct CTCSS tone (if used) and deviation level for the tone. Set the receiver and transmitter front panel switch to NORM. The MIC MODE switch on the transmitter front panel can be set to either Digital or Analog (this test does not make use of the front panel switch).

Ensure that the receiver and transmitter are connected to the repeater controller via the RJ45 cables on the front panel. In some systems, the receiver and transmitter may be connected directly together using the RJ45 cables.

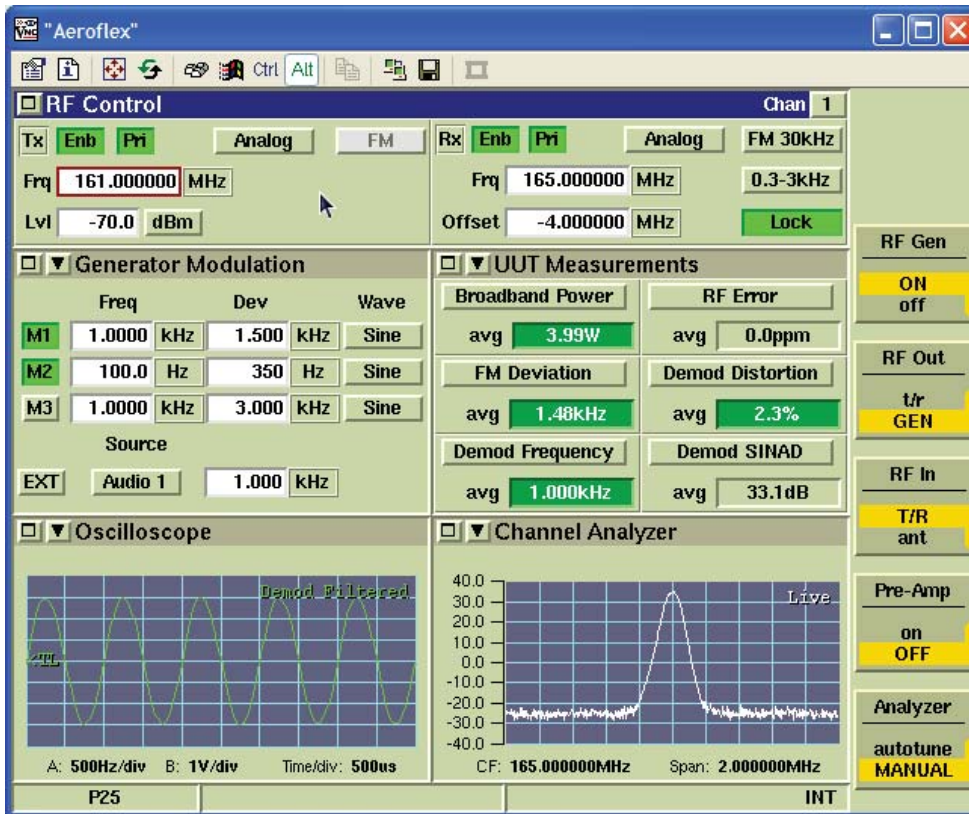

Figure C-36: System Analog Duplex Measurement

Demodulated Audio Frequency:

Check the Demod meter. The demodulated audio should read the same as the modulated input. The low and high limits are set for 995 Hz and 1005 Hz.

Distortion:

The distortion meter will read demodulated audio and give you a complete repeater system distortion reading. The high limit is set to 4.0 %.

Enter the System Distortion reading on the MT-4E Test Sheet.

Deviation Level:

Check the deviation level. Ideally the deviation level out of the transmitter should match the input to the receiver. The repeater deviation level matching is adjusted by the analog LVDS level adjustment that is available in both the receiver and transmitter (only one needs to be adjusted).

In the receiver or transmitter RSS, enter the Service section and click on "LVDS Level". A default value of 100 on the softpot slider should be close to matching receiver and transmitter deviation levels, however minor adjustments can be made. Adjust the softpot slider in the RSS as shown in Figure C-37 until a deviation of +/- 1.5 KHz (narrowband) or +/- 3.0 KHz (wideband) is measured on the IFR 3920. The low and high limits are set for 1.40 KHz and 1.60 KHz.

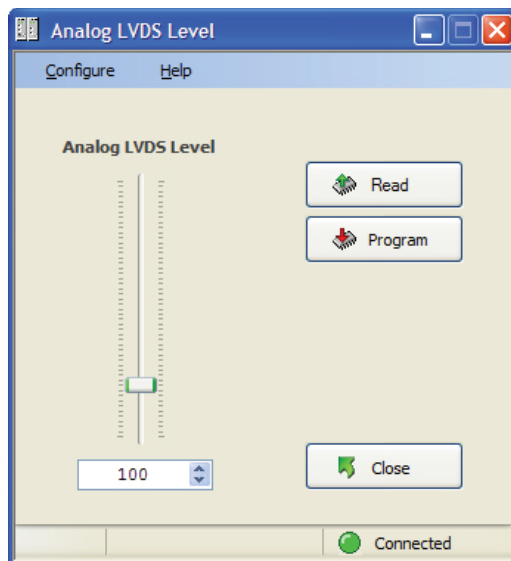

Figure C-37: RSS Receiver or Transmitter Analog LVDS Level Adjustment

Enter the Repeat Deviation Level reading on the MT-4E Test Sheet.

Duplex Digital Testing

Connect the IFR 3920 and Codan Radio as shown in Figure C-38.

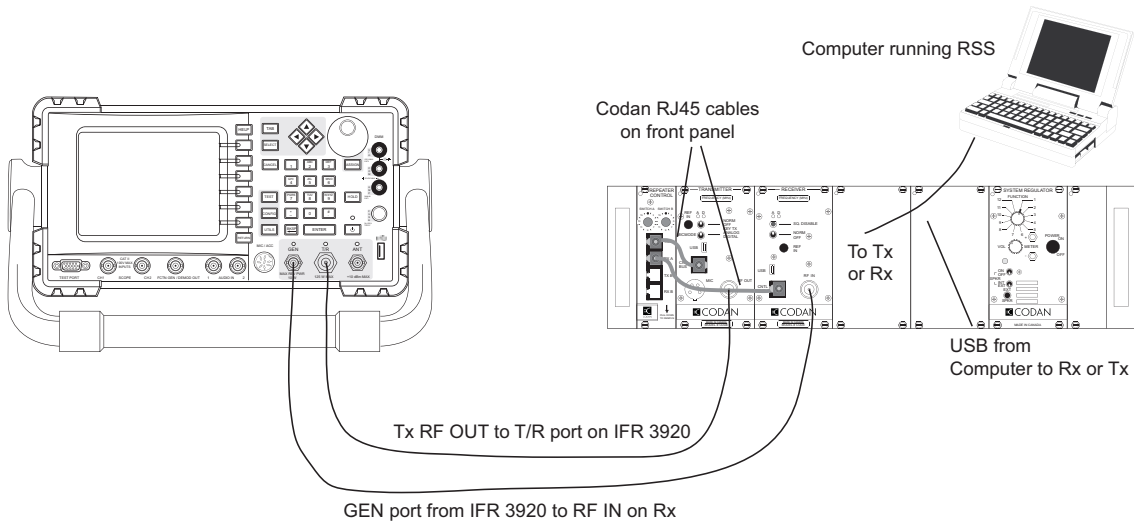

Figure C-38: System Duplex Digital Testing

On the IFR 3920, recall Codan setup 09 (Duplex Digital) from your internal drive as shown in Figure C-39. Enter the correct RF frequencies for the receiver and transmitter, and ensure that the RF Control is set to Phase 1 and it is set for the STORED SPCH test pattern (or optionally the 1011 test pattern). Inject the correct NAC (and TGID if programmed). Set the receiver and transmitter front panel switch to NORM. The MIC MODE switch on the transmitter front panel can be set to either Digital or Analog (this test does not make use of the front panel switch).

Ensure that the receiver and transmitter are connected to the repeater controller via the RJ45 cables on the front panel. In some systems, the receiver and transmitter may be connected directly together using the RJ45 cables.

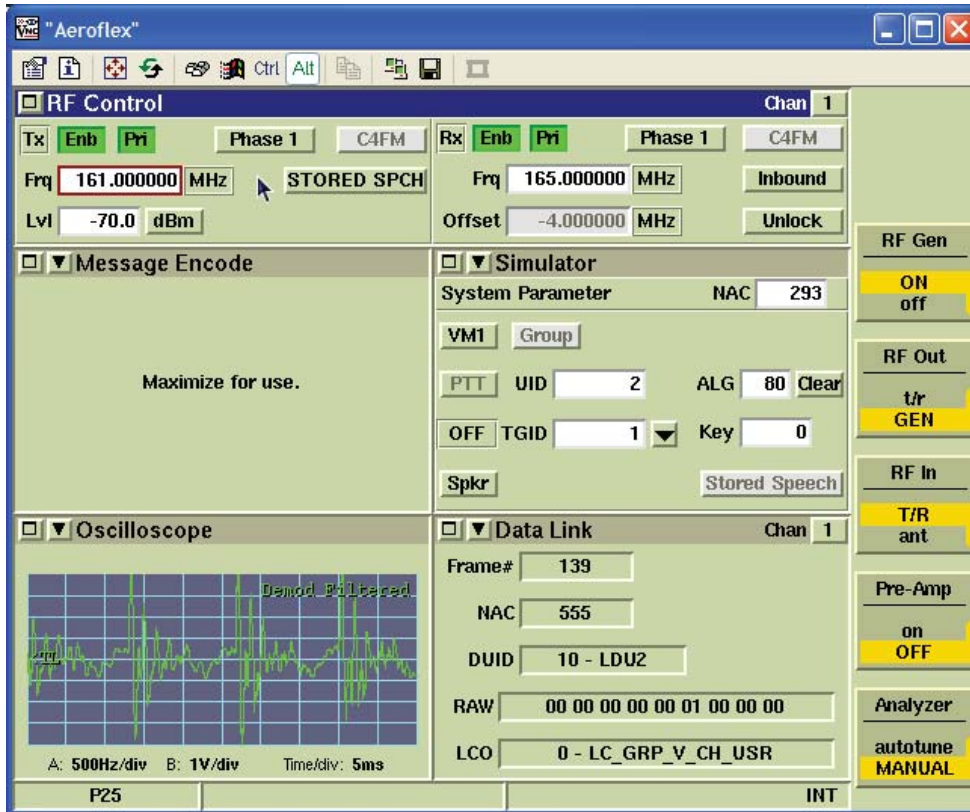

Figure C-39: System Digital Duplex Check

There are no specific measurements to make on this test, just verify that the system is operating correctly.

NAC:

Check to make sure your receiver unsquelches on the proper NAC. If the NAC is set for \$F7F in the receiver, ensure that the system transmits the NAC it receives.

Algorithm ID:

The Algorithm ID is typically set for 80 for CLEAR operation.

To ensure encrypted signals will pass through the repeater:

1. In the Simulator window, set the ALGID to 81 or select the DES option in the box to the right (this will change the ALGID to 81).
2. Ensure the KEY ID is set to 0.
3. Click on the Data Link menu to open the full window. The KID will read 0, the ALGID will read 81, and the MI data will be constantly changing.
4. Check the P25 Digital Repeat Capability Checked box on the MT-4E Test Sheet.

To check the TGID, Unit ID and Emergency Bit, click on the Message Encode menu expansion to show all of the P25 Message Encode information as shown in Figure C-40. Close the Message Encode window then click on the Data Link menu expansion to open the full Data Link window.

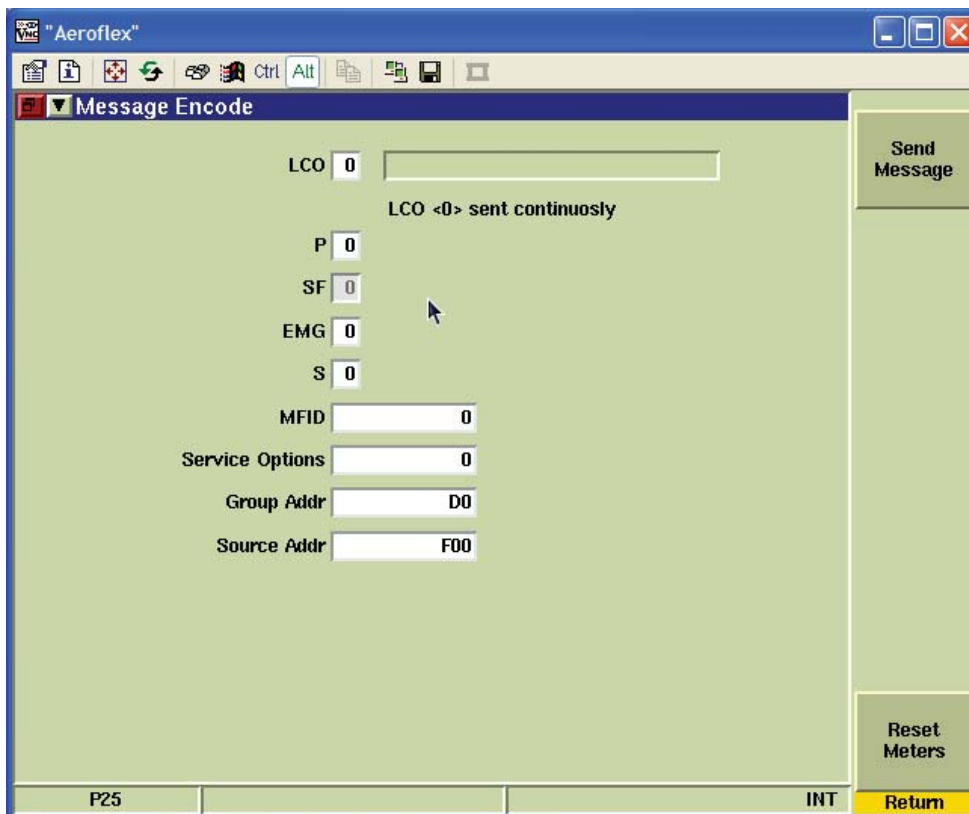

Figure C-40: System Digital Duplex Message Encode

TGID:

Check to make sure your receiver unsquelches on the proper TGID code (if used). Ensure that the system transmits the TGID code it receives.

Unit ID (SID):

Ensure that the system transmits the Unit ID code it receives.

*After changing the TGID or Unit ID the Send Message button must be clicked to send the information.

*The TGID and Unit ID programmed into the transmitter via the RSS are only transmitted when keying the transmitter in a non-repeater mode (see the Transmitter Digital Testing). In repeater mode the system transmits the TGID and Unit ID it receives.

Emergency Bit (EMG):

Ensure that the system transmits the Emergency Bit it receives.

Codan Radio Communications

43 Erie Street, Victoria, BC
Canada, V8V 1P8
www.codanradio.com
LMRsales@codanradio.com

Toll Free Canada and USA
Phone: 1-800-664-4066
Fax: 1-877-750-0004

International
Phone: 250-382-8268
Fax: 250-382-6139

©2014 Codan Limited All Rights Reserved.

MG-00C-4-0-0

 **CODAN**
RADIO COMMUNICATIONS

www.codanradio.com